

Agilent E5092A ENA Series Configurable Multiport Test Set

Service Guide

Second Edition



Manufacturing No. E5092-90100

October 2012

Notices

The information contained in this document is subject to change without notice.

This document contains proprietary information that is protected by copyright. All rights are reserved. No part of this document may be photocopied, reproduced, or translated to another language without the prior written consent of Agilent Technologies.

Microsoft®, MS-DOS®, Windows®, Visual C++®, Visual Basic®, VBA® and Excel® are registered

UNIX is a registered trademark in U.S. and other countries, licensed exclusively through X/Open Company Limited.

Portions ©Copyright 1996, Microsoft Corporation. All rights reserved.

© Copyright 2008 - 2012 Agilent Technologies

Manual Printing History

The manual's printing date and part number indicate its current edition. The printing date changes when a new edition is printed. (Minor corrections and updates that are incorporated at reprint do not cause the date to change.) The manual part number changes when extensive technical changes are incorporated.

February 2009 First Edition (part number: E5092-90100)

October 2012 Second Edition (part number: E5092-90100)

Safety Summary

The following general safety precautions must be observed during all phases of operation, service, and repair of this instrument. Failure to comply with these precautions or with specific WARNINGS elsewhere in this manual may impair the protection provided by the equipment. In addition it violates safety standards of design, manufacture, and intended use of the instrument.

Agilent Technologies assumes no liability for the customer's failure to comply with these requirements.

NOTE E5092A comply with INSTALLATION CATEGORY II and POLLUTION DEGREE 2 in IEC61010-1. E5092A are INDOOR USE product.

NOTE LEDs in E5092A are Class 1 in accordance with IEC60825-1.
CLASS 1 LED PRODUCT

- **Ground The Instrument**

To avoid electric shock hazard, the instrument chassis and cabinet must be connected to a safety earth ground by the supplied power cable with earth blade.
- **DO NOT Operate In An Explosive Atmosphere**

Do not operate the instrument in the presence of flammable gasses or fumes. Operation of any electrical instrument in such an environment constitutes a definite safety hazard.
- **Keep Away From Live Circuits**

Operating personnel must not remove instrument covers. Component replacement and internal adjustments must be made by qualified maintenance personnel. Do not replace components with the power cable connected. Under certain conditions, dangerous voltages may exist even with the power cable removed. To avoid injuries, always disconnect power and discharge circuits before touching them.
- **DO NOT Service Or Adjust Alone**

Do not attempt internal service or adjustment unless another person, capable of rendering first aid and resuscitation, is present.
- **DO NOT Substitute Parts Or Modify Instrument**

Because of the danger of introducing additional hazards, do not install substitute parts or perform unauthorized modifications to the instrument. Return the instrument to an Agilent Technologies Sales and Service Office for service and repair to ensure that safety features are maintained.
- **Dangerous Procedure Warnings**

Warnings, such as the example below, precede potentially dangerous procedures throughout this manual. Instructions contained in the warnings must be followed.

WARNING **Dangerous voltages, capable of causing death, are presenting this instrument. Use extreme caution when handling, testing, and adjusting this instrument.**

Safety Symbol

General definitions of safety symbols used on the instrument or in manuals are listed below.



Instruction Manual symbol: the product is marked with this symbol when it is necessary for the user to refer to the instrument manual.



Alternating current.



Direct current.



On (Supply).



Off (Supply).



In position of push-button switch.



Out position of push-button switch.



Frame (or chassis) terminal. A connection to the frame (chassis) of the equipment which normally include all exposed metal structure.

WARNING

This warning sign denotes a hazard. It calls attention to a procedure, practice, condition or the like, which, if not correctly performed or adhered to, could result in injury or death to personnel.

CAUTION

This Caution sign denotes a hazard. It calls attention to a procedure, practice, condition or the like, which, if not correctly performed or adhered to, could result in damage to or destruction of part or all of the product.

NOTE

Note denotes important information. It calls attention to a procedure, practice, condition or the like, which is essential to highlight.

Certification

Agilent Technologies certifies that this product met its published specifications at the time of shipment from the factory. Agilent Technologies further certifies that its calibration measurements are traceable to the United States National Institute of Standards and Technology, to the extent allowed by the Institution's calibration facility, or to the calibration facilities of other International Standards Organization members.

Warranty

This Agilent Technologies instrument product is warranted against defects in material and workmanship for a period corresponding to the individual warranty periods of its component products. Instruments are warranted for a period of one year. Fixtures and adapters are warranted for a period of 90 days. During the warranty period, Agilent Technologies Company will, at its option, either repair or replace products that prove to be defective.

For warranty service or repair, this product must be returned to a service facility designated by Agilent Technologies. Buyer shall prepay shipping charges to Agilent Technologies and Agilent Technologies shall pay shipping charges to return the product to Buyer. However, Buyer shall pay all shipping charges, duties, and taxes for products returned to Agilent Technologies from another country.

Agilent Technologies warrants that its software and firmware designated by Agilent Technologies for use with an instrument will execute its programming instruction when properly installed on that instrument. Agilent Technologies does not warrant that the operation of the instrument, or software, or firmware will be uninterrupted or error free.

Limitation of Warranty

The foregoing warranty shall not apply to defects resulting from improper or inadequate maintenance by Buyer, Buyer-supplied software or interfacing, unauthorized modification or misuse, operation outside the environmental specifications for the product, or improper site preparation or maintenance.

IMPORTANT

No other warranty is expressed or implied. Agilent Technologies specifically disclaims the implied warranties of merchantability and fitness for a particular purpose.

Exclusive Remedies

The remedies provided herein are buyer's sole and exclusive remedies. Agilent Technologies shall not be liable for any direct, indirect, special, incidental, or consequential damages, whether based on contract, tort, or any other legal theory.

Assistance

Product maintenance agreements and other customer assistance agreements are available for Agilent Technologies products.

For any assistance, contact your nearest Agilent Technologies Sales and Service Office. Addresses are provided at the back of this manual.

Typeface Conventions

Sample (bold)	Boldface type is used when a term is defined or emphasized.
<i>Sample (Italic)</i>	Italic type is used for emphasis.
Sample key	Indicates a hardkey (key on the front panel or external keyboard) labeled “Sample.” “key” may be omitted.
Sample menu/button/box	Indicates a menu/button/box on the screen labeled “Sample” which can be selected/executed by clicking. “Menu,” “button,” or “box” may be omitted.
Sample block/toolbar	Indicates a block (group of hardkeys) or a toolbar (setup toolbar) labeled “Sample.”
Sample 1 - Sample 2 - Sample 3	Indicates a sequential operation of Sample 1 , Sample 2 , and Sample 3 (menu, button, or box). “-” may be omitted.

1. General Information	
Organization of Service Manual	6
Instrument Covered by This Manual	7
Required Equipment	8
2. Performance Tests	
Introduction	10
Test Equipment Required	11
1. DC SOURCE OUTPUT VOLTAGE ACCURACY TEST	12
Description	12
Specification	12
Test equipment	12
2. DC SOURCE MAXIMUM CURRENT TEST	13
Description	13
Specification	13
Test equipment	13
3. LOAD MATCH, INSERTION LOSS, ISOLATION TEST for SWITCH 1 (SP4T, Port 1, 1A, 1B, 1C and 1D)	14
Description	14
Specification	14
Test equipment	16
4. LOAD MATCH, INSERTION LOSS, ISOLATION TEST for SWITCH 2 (SP4T, PORT 2, 2A, 2B, 2C and 2D)	17
Description	17
Specification	17
Test equipment	19
5. LOAD MATCH, INSERTION LOSS, ISOLATION for SWITCH 3 (SP4T, PORT 3, 3A, 3B, 3C and 3D)	20
Description	20
Specification	20
Test equipment	22
6. LOAD MATCH, INSERTION LOSS, ISOLATION for SWITCH 4 (SP4T, PORT 4, 4A, 4B, 4C and 4D)	23
Description	23
Specification	23
Test equipment	25
7. LOAD MATCH, INSERTION LOSS, ISOLATION for SWITCH 5 (SPDT, PORT 5, 5A and 5B)	26
Description	26
Specification	26
Test equipment	28
8. LOAD MATCH, INSERTION LOSS, ISOLATION for SWITCH 6 (SPDT, PORT 6, 6A and 6B)	29
Description	29
Specification	29
Test equipment	31
9. LOAD MATCH, INSERTION LOSS, ISOLATION for SWITCH 7 (SPDT, PORT 7, 7A and 7B)	32
Description	32
Specification	32
Test equipment	34
10. LOAD MATCH, INSERTION LOSS, ISOLATION for SWITCH 8 (SPDT, PORT 8, 8A and 8B)	35
Description	35
Specification	35
Test equipment	37
11. LOAD MATCH, INSERTION LOSS, ISOLATION for SWITCH 9 (SPDT, PORT 9, 9A and 9B)	38

Description	38
Specification	38
Test equipment	40
12. LOAD MATCH, INSERTION LOSS, ISOLATION for SWITCH 10 (SPDT, PORT 10, 10A and 10B).	41
Description	41
Specification	41
Test equipment	43
13. CONTROL LINE MAXIMUM CURRENT TEST	44
Description	44
Specification	44
Test equipment	44
E5092A Performance Test Record	45
DC Source Output Voltage Accuracy Test	45
DC Source Maximum Current Test	45
Load Match, Insertion Loss and Isolation Test for Switch 1 (SP4T, Port 1, 1A, 1B, 1C and 1D)	46
Load Match, Insertion Loss and Isolation Test for Switch 2(SP4T, Port 2, 2A, 2B, 2C and 2D)	62
Load Match, Insertion Loss and Isolation Test for Switch 3 (SP4T, Port 3, 3A, 3B, 3C and 3D)	78
Load Match, Insertion Loss and Isolation Test for Switch 4(SP4T, Port 4, 4A, 4B, 4C and 4D)	94
Load Match, Insertion Loss and Isolation Test for Switch 5(SPDT, 5COM, 5A and 5B)	110
Load Match, Insertion Loss and Isolation Test for Switch 6(SPDT, 6COM, 6A and 6B)	114
Load Match, Insertion Loss and Isolation Test for Switch 7 (SPDT, 7COM, 7A and 7B).	118
Load Match, Insertion Loss and Isolation Test for Switch 8 (SPDT, 8COM, 8A and 8B).	122
Load Match, Insertion Loss and Isolation Test for Switch 9 (SPDT, 9COM, 9A and 9B).	126
Load Match, Insertion Loss and Isolation Test for Switch 10(SPDT, 10COM, 10A and 10B)	130
Control Line Maximum Current Test	133

3. Troubleshooting

Introduction	136
To Troubleshoot the E5092A	137
Primary Trouble Isolation	137
Power Supply Troubleshooting	139
Check the Line Voltage and Fuse	139
Check the Power Supply Unit Output.	139
E5092A Setting Troubleshooting.	141
Check the E5092A Setting	141
Check the temperature control	142
Check the voltage output of the Control Lines.	143
Check control lines setting	143
Performance Test Failure Troubleshooting	145
Performance Test failure troubleshooting information.	145

4. Replaceable Parts

Ordering Information	148
Direct Mail Order System.	148
Replaceable Parts List for E5092A-020.	149
Top View (Major Assemblies)	149
Top View (Major Assemblies) (Under Switch Control USB PCA)	151
Top View (Cables)	152
Top View (Cables) (Under Switch Control USB PCA)	154
Top View (Semirigid Cables) (SP4T).	155
Top View (Semirigid Cables) (SPDT)	157
Top View (Miscellaneous Parts).	158

Top View (Miscellaneous Parts) (Under Switch Control USB PCA)	159
Bottom View (Cables)	160
Bottom View (Semirigid Cables) (SP4T)	161
Bottom View (Semirigid Cables) (SPDT)	162
Bottom View (Miscellaneous Parts)	163
SP4T Switch Assembly (Top View)	164
SP4T Switch Assembly (Bottom View)	165
SPDT Switch Assembly (Top View)	167
SPDT Switch Assembly (Bottom View)	168
Front Panel	169
Rear View	170
Side View	171
LED Assembly	172
Other Parts	173

5. Replacement Procedure

Replacing an Assembly	176
Required Tools	177
Replacement Procedure for E5092A-020	178
Outer Cover Removal	178
Front Chassis Detachment	179
Front Frame Removal	180
A1 Switch Control Board Removal	181
Power Supply Assembly Removal	182
Power Switch Removal	183
Main Board Removal	184
SP4T Switch Assembly Removal	185
SP4T Raptor Holder Assembly Removal	187
SPDT Switch Drawer Removal	189
SPDT Switch Assembly Removal	191
Switch Indicator LED PCA Removal	192

6. Post-Repair Procedures

Post-Repair Procedures	194
----------------------------------	-----

A. Power Requirement

Power Supply and fuse	200
Power Requirements	200
Setting up fuse	200
Power Cable	200
Turning the Power ON and OFF	202
Turning ON/OFF the power	202
Cutting supply of power	202

1 General Information

The Service Manual is a guide to servicing the E5092A Configurable Multiport Test Set. The manual contains information requisite to do performance tests, adjustments, troubleshootings, and repairs.

Organization of Service Manual

Tabs are used to divide the major chapters and appendices of this manual. The contents of each chapter and appendices in this manual as follows;

Chapter 1 , “General Information,”

The Service Manual is a guide to servicing the E5092A Configurable Multiport Test Set. The manual contains information requisite to do performance tests, adjustments, troubleshootings, and repairs.

Chapter 2 , “Performance Tests,”

This chapter provides information on how to verify the E5092A performance.

Chapter 3 , “Troubleshooting,”

This chapter provides procedure to isolate a faulty assembly in the E5092A.

Chapter 4 , “Replaceable Parts,”

This chapter contains information for ordering replacement parts for the E5092A.

Chapter 5 , “Replacement Procedure,”

This chapter provides procedure for removing and replacing the major assemblies in the E5092A.

Chapter 6 , “Post-Repair Procedures,”

This chapter lists the procedures required to verify the E5092A operation after an assembly is replaced with a new one.

Appendix A , “Power Requirement,”

Instrument Covered by This Manual

Agilent Technologies uses a two-part, ten-character serial number label (See Figure 1-1) attached to the instrument's rear panel. The first five characters are the serial prefix and the last five digits are the suffix.

Figure 1-1

Serial Number Label

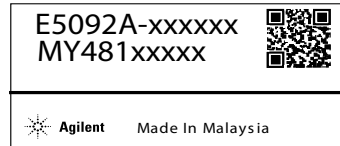

e5092ase0001

An instrument manufactured after the printing date of this manual may have serial number prefix that is not listed on the title page. This unlisted serial number prefix indicates the instrument is different from those described in this manual. The manual for this new instrument may be accompanied by a yellow Manual Changes supplement or have a different manual part number. This sheet contains “change information” that explains how to adapt the manual to the newer instrument.

In addition to change information, the supplement may contain information for correcting errors (Errata) in the manual. To keep this manual as current and accurate as possible, Agilent Technologies recommends that you periodically request the latest Manual Changes supplement. The supplement for this manual is identified by this manual's printing data and is available from Agilent Technologies. If the serial prefix or number of an instrument is lower than that on the title page of this manual, see Appendix A, Manual Changes. For information concerning a serial number prefix that is not listed on the title page or in the Manual change supplement, contact the nearest Agilent Technologies office.

Required Equipment

Table 1-1 lists the recommended equipment for performing maintenance on the E5092A.

Table 1-1 Recommended Test Equipment

Equipment	Critical specifications	Recommended Model	Qty.	Use* ¹
Network Analyzer	Frequency: 200 kHz to 20 GHz	Agilent N5230A	1	P
Multifunction Switch		Agilent 34980A	1	P
Multiplexer	40-channel Armature Multiplexer for 34980A	Agilent 34921A	1	P
Digital I/O	64-bit Digital I/O with memory and counter for 34980A	Agilent 34950A	1	P
Multimeter		Agilent 3458A	1	P
DC Power Supply	Programmable Triple Output	Agilent E3631A	1	P
ET	ET for DUT Control Line Test	Agilent E5092-66590	1	P
Load	50 Ω, DC to 26.5GHz(m)	Agilent p/n 00902-60003	1	P
Cable	BNC Cable, 120cm	Agilent p/n 8120-1840	3	P, A
	BNC(f) - Dual Banana(m)	Agilent p/n 1251-2277	3	
Cable	D-SUB 50pin (f)-(f)	Agilent p/n 5188-4493	2	P
	D-SUB 78pin (m)-(m)	Agilent p/n 5188-4494	1	
	D-SUB 15pin (m)-(m)	Agilent p/n 5188-4491	1	
	D-SUB 25pin (m)-(m)	Agilent p/n 5188-4492	1	
Cable	3.5mm Cable, 1m		4	P
Cable	GPIB Cable	Agilent 10833A	4	P
Cable	USB Cable	USB2-30	1	P
Adapter	SMB(f)-BNC(f) Adapter	Agilent p/n 1250-1236	1	P
Adapter	BNC T Adapter (f)-(m)-(f)	Agilent p/n 1250-0781	1	P
Torque Wrench		Agilent p/n 8710-1766	1	P

*1.P: Performance Tests, A: Adjustment Tests

2 Performance Tests

This chapter provides information on how to verify the E5092A performance.

Introduction

This literature provides the performance test procedures for the Agilent E5092A. The performance test names are listed in Table 2-1. The test procedures are described sequentially in the following pages.

The test name indicates the tested performance and to which performance group the tested performance belongs.

Each procedure consists of the following parts:

- Description:** describes the test procedure.
- Specification:** describes the performance verified in the test.
- Test Equipment:** describes test equipment required in the test.
- Procedure:** describes the test procedure step by step.

NOTE Allow the E5092A to warm up for at least 90 minutes before you execute any of the performance tests.

Perform all performance tests in an ambient temperature of 23 ± 5 °C

NOTE Before performing any tests, make extra copies of the performance test record pertaining to the test procedure. These are required in the test procedure. For explanation of how to use these records, see the performance test record at the end of this literature.

Table 2-1 The E5092A performance test procedure

Para.	Title
1	DC Source Output Voltage Accuracy Test
2	DC Source Maximum Current Test
3	Load Match, Insertion Loss, and Isolation Test for Switch 1 (SP4T, Port 1, 1A, 1B, 1C and 1D)
4	Load Match, Insertion Loss, and Isolation Test for Switch 2 (SP4T, Port 2, 2A, 2B, 2C and 2D)
5	Load Match, Insertion Loss, and Isolation Test for Switch 3 (SP4T, Port 3, 3A, 3B, 3C and 3D)
6	Load Match, Insertion Loss, and Isolation Test for Switch 4 (SP4T, Port 4, 4A, 4B, 4C and 4D)
7	Load Match, Insertion Loss, and Isolation Test for Switch 5 (SPDT, 5COM, 5A and 5B)
8	Load Match, Insertion Loss, and Isolation Test for Switch 6 (SPDT, 6COM, 6A and 6B)

Table 2-1 The E5092A performance test procedure

Para.	Title
9	Load Match, Insertion Loss, and Isolation Test for Switch 7 (SPDT, 7COM, 7A and 7B)
10	Load Match, Insertion Loss, and Isolation Test for Switch 8 (SPDT, 8COM, 8A and 8B)
11	Load Match, Insertion Loss, and Isolation Test for Switch 9 (SPDT, 9COM, 9A and 9B)
12	Load Match, Insertion Loss, and Isolation Test for Switch 10 (SPDT, 10COM, 10A and 10B)
13	Control Line Maximum Current Test

Test Equipment Required

The test equipment required to perform the entire performance test procedure is listed below.

Test Equipment:

Network Analyzer	Agilent N5230A Opt. 240 or 245
Calibration kit	Agilent 85052D

1. DC SOURCE OUTPUT VOLTAGE ACCURACY TEST

Description

This test measures the DC source output voltage for each control line.

Specification

@ 23°C ± 5°C (Warming up over 90 minutes)

± 3% of setting (+ 1V to 5V) at 1MΩ load impedance.

Test equipment

DC Power Supply	Agilent E3631A
Digital Multimeter	Agilent 34410A
Multifunction Switch/Measure Unit	Agilent 34980A
40-Channel Armature Multiplexer for 34980A	Agilent 34921A
ET	Agilent E5092-66590

2. DC SOURCE MAXIMUM CURRENT TEST

Description

This test measures limited current value for each control line.

Specification

@ 23°C ± 5°C (Warming up over 90 minutes)

150 mA for each source.

Test equipment

DC Power Supply	Agilent E3631A
Digital Multimeter	Agilent 34410A
Multifunction Switch/Measure Unit	Agilent 34980A
40-Channel Armature Multiplexer for 34980A	Agilent 34921A
ET	Agilent E5092-66590

3. LOAD MATCH, INSERTION LOSS, ISOLATION TEST for SWITCH 1 (SP4T, Port 1, 1A, 1B, 1C and 1D)**3. LOAD MATCH, INSERTION LOSS, ISOLATION TEST for SWITCH 1 (SP4T, Port 1, 1A, 1B, 1C and 1D)****Description**

This test checks the Load Match, insertion Loss and Isolation for ports 1A, 1B, 1C and 1D of the E5092A. These parameters checked at 50 MHz through 20 GHz with the N5230A Network Analyzer

Specification

@ 23°C ± 5°C (Warming up over 90 minutes)

Load Match (Selected port)

SP4T Switch	Specification
50 MHz to 2 GHz	17 dB
2 GHz to 4 GHz	11 dB
4 GHz to 8 GHz	8 dB
8 GHz to 10 GHz	7 dB
10 GHz to 18 GHz	4 dB
18 GHz to 20 GHz	4 dB

Load Match (Unselected port)

SP4T Switch	Specification
50 MHz to 3 GHz	17 dB
3 GHz to 10 GHz	11 dB
10 GHz to 16 GHz	8 dB
16 GHz to 18 GHz	6 dB
18 GHz to 20 GHz	4 dB

Load Match (Common port)

SP4T Switch	Specification
50 MHz to 2 GHz	16 dB
2 GHz to 4 GHz	11 dB
4 GHz to 8 GHz	8 dB
8 GHz to 10 GHz	7 dB

3. LOAD MATCH, INSERTION LOSS, ISOLATION TEST for SWITCH 1 (SP4T, Port 1, 1A, 1B, 1C and 1D)

10 GHz to 20 GHz	4 dB
------------------	------

Insertion Loss

SP4T Switch	Specification
50 MHz to 100 MHz	4 dB
100 MHz to 2 GHz	3.5 dB
2 GHz to 3 GHz	4.5 dB
3 GHz to 4GHz	5.5 dB
4 GHz to 6 GHz	6 dB
6 GHz to 8GHz	7.5 dB
8 GHz to 10 GHz	8.5 dB
10 GHz to 14GHz	9.5 dB
14 GHz to 18 GHz	10.5 dB
18 GHz to 20 GHz	12 dB

Isolation

Frequency	Specification
50 MHz to 500 MHz	65 dB
500 MHz to 1 GHz	80 dB
1 GHz to 2 GHz	85 dB
2 GHz to 6 GHz	90 dB
6 GHz to 10 GHz	85 dB
8 GHz to 10 GHz	75 dB
10 GHz to 18GHz	65 dB
18 GHz to 20 GHz	Over arbitrary test ports

Performance Tests

3. LOAD MATCH, INSERTION LOSS, ISOLATION TEST for SWITCH 1 (SP4T, Port 1, 1A, 1B, 1C and 1D)

Test equipment

Network Analyzer	Agilent N5230A Opt. 240 or 245
DC Power Supply	Agilent E3631A
Digital Multimeter	Agilent 34410A
Multifunction Switch/Measure Unit	Agilent 34980A
40-Channel Armature Multiplexer for 34980A	Agilent 34921A
ET	Agilent E5092-66590

4. LOAD MATCH, INSERTION LOSS, ISOLATION TEST for SWITCH 2 (SP4T, PORT 2, 2A, 2B, 2C and 2D)

4. LOAD MATCH, INSERTION LOSS, ISOLATION TEST for SWITCH 2 (SP4T, PORT 2, 2A, 2B, 2C and 2D)

Description

This test checks the Load Match, Insertion Loss and Isolation for ports 2A, 2B, 2C and 2D of the E5092A. These parameters checked at 50 MHz through 20 GHz with the N5230A Network Analyzer.

Specification

@ 23°C ± 5°C (Warming up over 90 minutes)

Load Match (Selected port)

SP4T Switch	Specification
50 MHz to 2 GHz	17 dB
2 GHz to 4 GHz	11 dB
4 GHz to 8 GHz	8 dB
8 GHz to 10 GHz	7 dB
10 GHz to 18 GHz	4 dB
18 GHz to 20 GHz	4 dB

Load Match (Unselected port)

SP4T Switch	Specification
50 MHz to 3 GHz	17 dB
3 GHz to 10 GHz	11 dB
10 GHz to 16 GHz	8 dB
16 GHz to 18 GHz	6 dB
18 GHz to 20 GHz	4 dB

Load Match (Common port)

SP4T Switch	Specification
50 MHz to 2 GHz	16 dB
2 GHz to 4 GHz	11 dB
4 GHz to 8 GHz	8 dB
8 GHz to 10 GHz	7 dB

Performance Tests

4. LOAD MATCH, INSERTION LOSS, ISOLATION TEST for SWITCH 2 (SP4T, PORT 2, 2A, 2B, 2C and 2D)

10 GHz to 20 GHz	4 dB
------------------	------

Insertion Loss

SP4T Switch	Specification
50 MHz to 100 MHz	4 dB
100 MHz to 2 GHz	3.5 dB
2 GHz to 3 GHz	4.5 dB
3 GHz to 4GHz	5.5 dB
4 GHz to 6 GHz	6 dB
6 GHz to 8GHz	7.5 dB
8 GHz to 10 GHz	8.5 dB
10 GHz to 14GHz	9.5 dB
14 GHz to 18 GHz	10.5 dB
18 GHz to 20 GHz	12 dB

Isolation

Frequency	Specification
50 MHz to 500 MHz	65 dB
500 MHz to 1 GHz	80 dB
1 GHz to 2 GHz	85 dB
2 GHz to 6 GHz	90 dB
6 GHz to 10 GHz	85 dB
8 GHz to 10 GHz	75 dB
10 GHz to 18GHz	65 dB
18 GHz to 20 GHz	Over arbitrary test ports

4. LOAD MATCH, INSERTION LOSS, ISOLATION TEST for SWITCH 2 (SP4T, PORT 2, 2A, 2B, 2C and 2D)

Test equipment

Network Analyzer	Agilent N5230A Opt. 240 or 245
DC Power Supply	Agilent E3631A
Digital Multimeter	Agilent 34410A
Multifunction Switch/Measure Unit	Agilent 34980A
40-Channel Armature Multiplexer for 34980A	Agilent 34921A
ET	Agilent E5092-66590

5. LOAD MATCH, INSERTION LOSS, ISOLATION for SWITCH 3 (SP4T, PORT 3, 3A, 3B, 3C and 3D)**Description**

This test checks the Load Match, Insertion loss and Isolation for ports 3A, 3B, 3C and 3D of the E5092A. These parameters checked at 50 MHz through 20 GHz with the N5230A Network Analyzer.

Specification

@ 23°C ± 5°C (Warming up over 90 minutes)

Load Match (Selected port)

SP4T Switch	Specification
50 MHz to 2 GHz	17 dB
2 GHz to 4 GHz	11 dB
4 GHz to 8 GHz	8 dB
8 GHz to 10 GHz	7 dB
10 GHz to 18 GHz	4 dB
18 GHz to 20 GHz	4 dB

Load Match (Unselected port)

SP4T Switch	Specification
50 MHz to 3 GHz	17 dB
3 GHz to 10 GHz	11 dB
10 GHz to 16 GHz	8 dB
16 GHz to 18 GHz	6 dB
18 GHz to 20 GHz	4 dB

Load Match (Common port)

SP4T Switch	Specification
50 MHz to 2 GHz	16 dB
2 GHz to 4 GHz	11 dB
4 GHz to 8 GHz	8 dB
8 GHz to 10 GHz	7 dB

5. LOAD MATCH, INSERTION LOSS, ISOLATION for SWITCH 3 (SP4T, PORT 3, 3A, 3B, 3C and 3D)

10 GHz to 20 GHz	4 dB
------------------	------

Insertion Loss

SP4T Switch	Specification
50 MHz to 100 MHz	4 dB
100 MHz to 2 GHz	3.5 dB
2 GHz to 3 GHz	4.5 dB
3 GHz to 4GHz	5.5 dB
4 GHz to 6 GHz	6 dB
6 GHz to 8GHz	7.5 dB
8 GHz to 10 GHz	8.5 dB
10 GHz to 14GHz	9.5 dB
14 GHz to 18 GHz	10.5 dB
18 GHz to 20 GHz	12 dB

Isolation

Frequency	Specification
50 MHz to 500 MHz	65 dB
500 MHz to 1 GHz	80 dB
1 GHz to 2 GHz	85 dB
2 GHz to 6 GHz	90 dB
6 GHz to 10 GHz	85 dB
8 GHz to 10 GHz	75 dB
10 GHz to 18GHz	65 dB
18 GHz to 20 GHz	Over arbitrary test ports

Performance Tests

5. LOAD MATCH, INSERTION LOSS, ISOLATION for SWITCH 3 (SP4T, PORT 3, 3A, 3B, 3C and 3D)

Test equipment

Network Analyzer	Agilent N5230A Opt. 240 or 245
DC Power Supply	Agilent E3631A
Digital Multimeter	Agilent 34410A
Multifunction Switch/Measure Unit	Agilent 34980A
40-Channel Armature Multiplexer for 34980A	Agilent 34921A
ET	Agilent E5092-66590

6. LOAD MATCH, INSERTION LOSS, ISOLATION for SWITCH 4 (SP4T, PORT 4, 4A, 4B, 4C and 4D)

6. LOAD MATCH, INSERTION LOSS, ISOLATION for SWITCH 4 (SP4T, PORT 4, 4A, 4B, 4C and 4D)

Description

This test checks the Load Match, Insertion Loss and Isolation for ports 4A, 4B, 4C and 4D of the E5092A. These parameters checked at 50 MHz through 20 GHz with the N5230A Network Analyzer.

Specification

@ 23°C ± 5°C (Warming up over 90 minutes)

Load Match (Selected port)

SP4T Switch	Specification
50 MHz to 2 GHz	17 dB
2 GHz to 4 GHz	11 dB
4 GHz to 8 GHz	8 dB
8 GHz to 10 GHz	7 dB
10 GHz to 18 GHz	4 dB
18 GHz to 20 GHz	4 dB

Load Match (Unselected port)

SP4T Switch	Specification
50 MHz to 3 GHz	17 dB
3 GHz to 10 GHz	11 dB
10 GHz to 16 GHz	8 dB
16 GHz to 18 GHz	6 dB
18 GHz to 20 GHz	4 dB

Load Match (Common port)

SP4T Switch	Specification
50 MHz to 2 GHz	16 dB
2 GHz to 4 GHz	11 dB
4 GHz to 8 GHz	8 dB
8 GHz to 10 GHz	7 dB

Performance Tests

6. LOAD MATCH, INSERTION LOSS, ISOLATION for SWITCH 4 (SP4T, PORT 4, 4A, 4B, 4C and 4D)

10 GHz to 20 GHz	4 dB
------------------	------

Insertion Loss

SP4T Switch	Specification
50 MHz to 100 MHz	4 dB
100 MHz to 2 GHz	3.5 dB
2 GHz to 3 GHz	4.5 dB
3 GHz to 4GHz	5.5 dB
4 GHz to 6 GHz	6 dB
6 GHz to 8GHz	7.5 dB
8 GHz to 10 GHz	8.5 dB
10 GHz to 14GHz	9.5 dB
14 GHz to 18 GHz	10.5 dB
18 GHz to 20 GHz	12 dB

Isolation

Frequency	Specification
50 MHz to 500 MHz	65 dB
500 MHz to 1 GHz	80 dB
1 GHz to 2 GHz	85 dB
2 GHz to 6 GHz	90 dB
6 GHz to 10 GHz	85 dB
8 GHz to 10 GHz	75 dB
10 GHz to 18GHz	65 dB
18 GHz to 20 GHz	Over arbitrary test ports

6. LOAD MATCH, INSERTION LOSS, ISOLATION for SWITCH 4 (SP4T, PORT 4, 4A, 4B, 4C and 4D)**Test equipment**

Network Analyzer	Agilent N5230A Opt. 240 or 245
DC Power Supply	Agilent E3631A
Digital Multimeter	Agilent 34410A
Multifunction Switch/Measure Unit	Agilent 34980A
40-Channel Armature Multiplexer for 34980A	Agilent 34921A
ET	Agilent E5092-66590

7. LOAD MATCH, INSERTION LOSS, ISOLATION for SWITCH 5 (SPDT, PORT 5, 5A and 5B)**Description**

This test checks the Load Match, Insertion Loss and Isolation for ports 5COM, 5A and 5B of the E5092A. These parameters checked at 50 MHz through 20 GHz with the N5230A Network Analyzer.

Specification

@ 23°C ± 5°C (Warming up over 90 minutes)

Load Match (Selected port)

SPDT Switch	Specification
50 MHz to 2 GHz	17 dB
2 GHz to 4 GHz	11 dB
4 GHz to 8 GHz	8 dB
8 GHz to 10 GHz	7 dB
10 GHz to 18 GHz	4 dB
18 GHz to 20 GHz	4 dB

Load Match (Unselected port)

SPDT Switch	Specification
50 MHz to 3 GHz	17 dB
3 GHz to 10 GHz	11 dB
10 GHz to 16 GHz	8 dB
16 GHz to 18 GHz	6 dB
18 GHz to 20 GHz	4 dB

Load Match (Common port)

SPDT Switch	Specification
50 MHz to 2 GHz	16 dB
2 GHz to 4 GHz	11 dB
4 GHz to 8 GHz	8 dB
8 GHz to 10 GHz	7 dB

7. LOAD MATCH, INSERTION LOSS, ISOLATION for SWITCH 5 (SPDT, PORT 5, 5A and 5B)

10 GHz to 20 GHz	4 dB
------------------	------

Insertion Loss

SPDT Switch	Specification
50 MHz to 100 MHz	4 dB
100 MHz to 2 GHz	3.5 dB
2 GHz to 3 GHz	4.5 dB
3 GHz to 4GHz	5 dB
4 GHz to 6 GHz	5.5 dB
6 GHz to 8GHz	7 dB
8 GHz to 10 GHz	8 dB
10 GHz to 14GHz	8.5 dB
14 GHz to 18 GHz	10 dB
18 GHz to 20 GHz	11 dB

Isolation

Frequency	Specification
50 MHz to 500 MHz	65 dB
500 MHz to 1 GHz	80 dB
1 GHz to 2 GHz	85 dB
2 GHz to 6 GHz	90 dB
6 GHz to 10 GHz	85 dB
8 GHz to 10 GHz	75 dB
10 GHz to 18GHz	65 dB
18 GHz to 20 GHz	Over arbitrary test ports

Performance Tests

7. LOAD MATCH, INSERTION LOSS, ISOLATION for SWITCH 5 (SPDT, PORT 5, 5A and 5B)

Test equipment

Network Analyzer	Agilent N5230A Opt. 240 or 245
DC Power Supply	Agilent E3631A
Digital Multimeter	Agilent 34410A
Multifunction Switch/Measure Unit	Agilent 34980A
40-Channel Armature Multiplexer for 34980A	Agilent 34921A
ET	Agilent E5092-66590

8. LOAD MATCH, INSERTION LOSS, ISOLATION for SWITCH 6 (SPDT, PORT 6, 6A and 6B)

8. LOAD MATCH, INSERTION LOSS, ISOLATION for SWITCH 6 (SPDT, PORT 6, 6A and 6B)

Description

This test checks the Load Match, Insertion Loss and Isolation for ports 6COM, 6A and 6B of the E5092A. These parameters checked at 50 MHz through 20 GHz with the N5230A Network Analyzer.

Specification

@ 23°C ± 5°C (Warming up over 90 minutes)

Load Match (Selected port)

SPDT Switch	Specification
50 MHz to 2 GHz	17 dB
2 GHz to 4 GHz	11 dB
4 GHz to 8 GHz	8 dB
8 GHz to 10 GHz	7 dB
10 GHz to 18 GHz	4 dB
18 GHz to 20 GHz	4 dB

Load Match (Unselected port)

SPDT Switch	Specification
50 MHz to 3 GHz	17 dB
3 GHz to 10 GHz	11 dB
10 GHz to 16 GHz	8 dB
16 GHz to 18 GHz	6 dB
18 GHz to 20 GHz	4 dB

Load Match (Common port)

SPDT Switch	Specification
50 MHz to 2 GHz	16 dB
2 GHz to 4 GHz	11 dB
4 GHz to 8 GHz	8 dB
8 GHz to 10 GHz	7 dB

Performance Tests

8. LOAD MATCH, INSERTION LOSS, ISOLATION for SWITCH 6 (SPDT, PORT 6, 6A and 6B)

10 GHz to 20 GHz	4 dB
------------------	------

Insertion Loss

SPDT Switch	Specification
50 MHz to 100 MHz	4 dB
100 MHz to 2 GHz	3.5 dB
2 GHz to 3 GHz	4.5 dB
3 GHz to 4GHz	5 dB
4 GHz to 6 GHz	5.5 dB
6 GHz to 8GHz	7 dB
8 GHz to 10 GHz	8 dB
10 GHz to 14GHz	8.5 dB
14 GHz to 18 GHz	10 dB
18 GHz to 20 GHz	11 dB

Isolation

Frequency	Specification
50 MHz to 500 MHz	65 dB
500 MHz to 1 GHz	80 dB
1 GHz to 2 GHz	85 dB
2 GHz to 6 GHz	90 dB
6 GHz to 10 GHz	85 dB
8 GHz to 10 GHz	75 dB
10 GHz to 18GHz	65 dB
18 GHz to 20 GHz	Over arbitrary test ports

8. LOAD MATCH, INSERTION LOSS, ISOLATION for SWITCH 6 (SPDT, PORT 6, 6A and 6B)

Test equipment

Network Analyzer	Agilent N5230A Opt. 240 or 245
DC Power Supply	Agilent E3631A
Digital Multimeter	Agilent 34410A
Multifunction Switch/Measure Unit	Agilent 34980A
40-Channel Armature Multiplexer for 34980A	Agilent 34921A
ET	Agilent E5092-66590

2. Performance Tests

9. LOAD MATCH, INSERTION LOSS, ISOLATION for SWITCH 7 (SPDT, PORT 7, 7A and 7B)**Description**

This test checks the Load Match, Insertion Loss and Isolation for ports 7COM, 7A and 7B of the E5092A. These parameters checked at 50 MHz through 20 GHz with the N5230A Network Analyzer.

Specification

@ 23°C ± 5°C (Warming up over 90 minutes)

Load Match (Selected port)

SPDT Switch	Specification
50 MHz to 2 GHz	17 dB
2 GHz to 4 GHz	11 dB
4 GHz to 8 GHz	8 dB
8 GHz to 10 GHz	7 dB
10 GHz to 18 GHz	4 dB
18 GHz to 20 GHz	4 dB

Load Match (Unselected port)

SPDT Switch	Specification
50 MHz to 3 GHz	17 dB
3 GHz to 10 GHz	11 dB
10 GHz to 16 GHz	8 dB
16 GHz to 18 GHz	6 dB
18 GHz to 20 GHz	4 dB

Load Match (Common port)

SPDT Switch	Specification
50 MHz to 2 GHz	16 dB
2 GHz to 4 GHz	11 dB
4 GHz to 8 GHz	8 dB
8 GHz to 10 GHz	7 dB

9. LOAD MATCH, INSERTION LOSS, ISOLATION for SWITCH 7 (SPDT, PORT 7, 7A and 7B)

10 GHz to 20 GHz	4 dB
------------------	------

Insertion Loss

SPDT Switch	Specification
50 MHz to 100 MHz	4 dB
100 MHz to 2 GHz	3.5 dB
2 GHz to 3 GHz	4.5 dB
3 GHz to 4GHz	5 dB
4 GHz to 6 GHz	5.5 dB
6 GHz to 8GHz	7 dB
8 GHz to 10 GHz	8 dB
10 GHz to 14GHz	8.5 dB
14 GHz to 18 GHz	10 dB
18 GHz to 20 GHz	11 dB

Isolation

Frequency	Specification
50 MHz to 500 MHz	65 dB
500 MHz to 1 GHz	80 dB
1 GHz to 2 GHz	85 dB
2 GHz to 6 GHz	90 dB
6 GHz to 10 GHz	85 dB
8 GHz to 10 GHz	75 dB
10 GHz to 18GHz	65 dB
18 GHz to 20 GHz	Over arbitrary test ports

Performance Tests

9. LOAD MATCH, INSERTION LOSS, ISOLATION for SWITCH 7 (SPDT, PORT 7, 7A and 7B)

Test equipment

Network Analyzer	Agilent N5230A Opt. 240 or 245
DC Power Supply	Agilent E3631A
Digital Multimeter	Agilent 34410A
Multifunction Switch/Measure Unit	Agilent 34980A
40-Channel Armature Multiplexer for 34980A	Agilent 34921A
ET	Agilent E5092-66590

10. LOAD MATCH, INSERTION LOSS, ISOLATION for SWITCH 8 (SPDT, PORT 8, 8A and 8B)

10. LOAD MATCH, INSERTION LOSS, ISOLATION for SWITCH 8 (SPDT, PORT 8, 8A and 8B)

Description

This test checks the Load Match, Insertion Loss and Isolation for ports 8COM, 8A and 8B of the E5092A. These parameters checked at 50 MHz through 20 GHz with the N5230A Network Analyzer.

Specification

@ 23°C ± 5°C (Warming up over 90 minutes)

Load Match (Selected port)

SPDT Switch	Specification
50 MHz to 2 GHz	17 dB
2 GHz to 4 GHz	11 dB
4 GHz to 8 GHz	8 dB
8 GHz to 10 GHz	7 dB
10 GHz to 18 GHz	4 dB
18 GHz to 20 GHz	4 dB

Load Match (Unselected port)

SPDT Switch	Specification
50 MHz to 3 GHz	17 dB
3 GHz to 10 GHz	11 dB
10 GHz to 16 GHz	8 dB
16 GHz to 18 GHz	6 dB
18 GHz to 20 GHz	4 dB

Load Match (Common port)

SPDT Switch	Specification
50 MHz to 2 GHz	16 dB
2 GHz to 4 GHz	11 dB
4 GHz to 8 GHz	8 dB
8 GHz to 10 GHz	7 dB

Performance Tests

10. LOAD MATCH, INSERTION LOSS, ISOLATION for SWITCH 8 (SPDT, PORT 8, 8A and 8B)

10 GHz to 20 GHz	4 dB
------------------	------

Insertion Loss

SPDT Switch	Specification
50 MHz to 100 MHz	4 dB
100 MHz to 2 GHz	3.5 dB
2 GHz to 3 GHz	4.5 dB
3 GHz to 4GHz	5 dB
4 GHz to 6 GHz	5.5 dB
6 GHz to 8GHz	7 dB
8 GHz to 10 GHz	8 dB
10 GHz to 14GHz	8.5 dB
14 GHz to 18 GHz	10 dB
18 GHz to 20 GHz	11 dB

Isolation

Frequency	Specification
50 MHz to 500 MHz	65 dB
500 MHz to 1 GHz	80 dB
1 GHz to 2 GHz	85 dB
2 GHz to 6 GHz	90 dB
6 GHz to 10 GHz	85 dB
8 GHz to 10 GHz	75 dB
10 GHz to 18GHz	65 dB
18 GHz to 20 GHz	Over arbitrary test ports

10. LOAD MATCH, INSERTION LOSS, ISOLATION for SWITCH 8 (SPDT, PORT 8, 8A and 8B)

Test equipment

Network Analyzer	Agilent N5230A Opt. 240 or 245
DC Power Supply	Agilent E3631A
Digital Multimeter	Agilent 34410A
Multifunction Switch/Measure Unit	Agilent 34980A
40-Channel Armature Multiplexer for 34980A	Agilent 34921A
ET	Agilent E5092-66590

2. Performance Tests

11. LOAD MATCH, INSERTION LOSS, ISOLATION for SWITCH 9 (SPDT, PORT 9, 9A and 9B)**Description**

This test checks the Load Match, Insertion Loss and Isolation for ports 9COM, 9A and 9B of the E5092A. These parameters checked at 50 MHz through 20 GHz with the N5230A Network Analyzer.

Specification

@ 23°C ± 5°C (Warming up over 90 minutes)

Load Match (Selected port)

SPDT Switch	Specification
50 MHz to 2 GHz	17 dB
2 GHz to 4 GHz	11 dB
4 GHz to 8 GHz	8 dB
8 GHz to 10 GHz	7 dB
10 GHz to 18 GHz	4 dB
18 GHz to 20 GHz	4 dB

Load Match (Unselected port)

SPDT Switch	Specification
50 MHz to 3 GHz	17 dB
3 GHz to 10 GHz	11 dB
10 GHz to 16 GHz	8 dB
16 GHz to 18 GHz	6 dB
18 GHz to 20 GHz	4 dB

Load Match (Common port)

SPDT Switch	Specification
50 MHz to 2 GHz	16 dB
2 GHz to 4 GHz	11 dB
4 GHz to 8 GHz	8 dB
8 GHz to 10 GHz	7 dB

11. LOAD MATCH, INSERTION LOSS, ISOLATION for SWITCH 9 (SPDT, PORT 9, 9A and 9B)

10 GHz to 20 GHz	4 dB
------------------	------

Insertion Loss

SPDT Switch	Specification
50 MHz to 100 MHz	4 dB
100 MHz to 2 GHz	3.5 dB
2 GHz to 3 GHz	4.5 dB
3 GHz to 4GHz	5 dB
4 GHz to 6 GHz	5.5 dB
6 GHz to 8GHz	7 dB
8 GHz to 10 GHz	8 dB
10 GHz to 14GHz	8.5 dB
14 GHz to 18 GHz	10 dB
18 GHz to 20 GHz	11 dB

Isolation

Frequency	Specification
50 MHz to 500 MHz	65 dB
500 MHz to 1 GHz	80 dB
1 GHz to 2 GHz	85 dB
2 GHz to 6 GHz	90 dB
6 GHz to 10 GHz	85 dB
8 GHz to 10 GHz	75 dB
10 GHz to 18GHz	65 dB
18 GHz to 20 GHz	Over arbitrary test ports

Performance Tests

11. LOAD MATCH, INSERTION LOSS, ISOLATION for SWITCH 9 (SPDT, PORT 9, 9A and 9B)

Test equipment

Network Analyzer	Agilent N5230A Opt. 240 or 245
DC Power Supply	Agilent E3631A
Digital Multimeter	Agilent 34410A
Multifunction Switch/Measure Unit	Agilent 34980A
40-Channel Armature Multiplexer for 34980A	Agilent 34921A
ET	Agilent E5092-66590

12. LOAD MATCH, INSERTION LOSS, ISOLATION for SWITCH 10 (SPDT, PORT 10, 10A and 10B)

Description

This test checks the Load Match, Insertion Loss and Isolation for ports 10COM, 10A and 10B of the E5092A. These parameters checked at 50 MHz through 20 GHz with the N5230A Network Analyzer.

Specification

@ 23°C ± 5°C (Warming up over 90 minutes)

Load Match (Selected port)

SPDT Switch	Specification
50 MHz to 2 GHz	17 dB
2 GHz to 4 GHz	11 dB
4 GHz to 8 GHz	8 dB
8 GHz to 10 GHz	7 dB
10 GHz to 18 GHz	4 dB
18 GHz to 20 GHz	4 dB

Load Match (Unselected port)

SPDT Switch	Specification
50 MHz to 3 GHz	17 dB
3 GHz to 10 GHz	11 dB
10 GHz to 16 GHz	8 dB
16 GHz to 18 GHz	6 dB
18 GHz to 20 GHz	4 dB

Load Match (Common port)

SPDT Switch	Specification
50 MHz to 2 GHz	16 dB
2 GHz to 4 GHz	11 dB
4 GHz to 8 GHz	8 dB
8 GHz to 10 GHz	7 dB

Performance Tests

12. LOAD MATCH, INSERTION LOSS, ISOLATION for SWITCH 10 (SPDT, PORT 10, 10A and 10B)

10 GHz to 20 GHz	4 dB
------------------	------

Insertion Loss

SPDT Switch	Specification
50 MHz to 100 MHz	4 dB
100 MHz to 2 GHz	3.5 dB
2 GHz to 3 GHz	4.5 dB
3 GHz to 4GHz	5 dB
4 GHz to 6 GHz	5.5 dB
6 GHz to 8GHz	7 dB
8 GHz to 10 GHz	8 dB
10 GHz to 14GHz	8.5 dB
14 GHz to 18 GHz	10 dB
18 GHz to 20 GHz	11 dB

Isolation

Frequency	Specification
50 MHz to 500 MHz	65 dB
500 MHz to 1 GHz	80 dB
1 GHz to 2 GHz	85 dB
2 GHz to 6 GHz	90 dB
6 GHz to 10 GHz	85 dB
8 GHz to 10 GHz	75 dB
10 GHz to 18GHz	65 dB
18 GHz to 20 GHz	Over arbitrary test ports

12. LOAD MATCH, INSERTION LOSS, ISOLATION for SWITCH 10 (SPDT, PORT 10, 10A and 10B)**Test equipment**

Network Analyzer	Agilent N5230A Opt. 240 or 245
DC Power Supply	Agilent E3631A
Digital Multimeter	Agilent 34410A
Multifunction Switch/Measure Unit	Agilent 34980A
40-Channel Armature Multiplexer for 34980A	Agilent 34921A
ET	Agilent E5092-66590

13. CONTROL LINE MAXIMUM CURRENT TEST

Description

This test measures the current meter accuracy in control line paths.

Specification

@ 23°C ± 5°C (Warming up over 90 minutes)

Group A, B: 50 mA in total of each group

Group C, D: 500 uA in total of each group

Test equipment

Network Analyzer	Agilent N5230A Opt. 240 or 245
DC Power Supply	Agilent E3631A
Digital Multimeter	Agilent 34410A
Multifunction Switch/Measure Unit	Agilent 34980A
40-Channel Armature Multiplexer for 34980A	Agilent 34921A
ET	Agilent E5092-66590

E5092A Performance Test Record

Agilent Technologies E5092A Configurable Multiport Test Set

Serial Number:		Option:	
Temperature:	°C	Test Date:	
Humidity:	%RH	Tested by:	

DC Source Output Voltage Accuracy Test

Control Line Group	DC Source Voltage [V]	Test Limit [V]	Test Result [V]	Measurement Uncertainty [V]	TAR
A	1.000	± 0.030		± 0.000015	2058
A	5.000	± 0.150		± 0.000054	2803
B	1.000	± 0.030		± 0.000015	2058
B	5.000	± 0.150		± 0.000054	2803
C	1.000	± 0.030		± 0.000015	2058
C	5.000	± 0.150		± 0.000054	2803
D	1.000	± 0.030		± 0.000015	2058
D	5.000	± 0.150		± 0.000054	2803

DC Source Maximum Current Test

Control Line Group	Lower Test Limit [mA]	Test Limit[mA]	Measurement Uncertainty [mA]
A	≥ 150		± 0.0582
B	≥ 150		± 0.0582
C	≥ 150		± 0.0582
D	≥ 150		± 0.0582

Load Match, Insertion Loss and Isolation Test for Switch 1 (SP4T, Port 1, 1A, 1B, 1C and 1D)

Load Match (Unselected)

Port (Selected Port)	Frequency Range [Hz]	Test Limit [dB]	Test Result [dB]	Measurement Uncertainty [dB]
1B (1A)	50M to 3G	< -17.0		± 0.43
	3G to 10G	< -11.0		± 0.37
	10G to 16G	< -8.0		± 0.28
	16G to 18G	< -6.0		± 0.28
	18G to 20G	< -4.0		± 0.35
1C (1A)	50M to 3G	< -17.0		± 0.43
	3G to 10G	< -11.0		± 0.37
	10G to 16G	< -8.0		± 0.28
	16G to 18G	< -6.0		± 0.28
	18G to 20G	< -4.0		± 0.35
1D (1A)	50M to 3G	< -17.0		± 0.43
	3G to 10G	< -11.0		± 0.37
	10G to 16G	< -8.0		± 0.28
	16G to 18G	< -6.0		± 0.28
	18G to 20G	< -4.0		± 0.35
1A (1B)	50M to 3G	< -17.0		± 0.43
	3G to 10G	< -11.0		± 0.37
	10G to 16G	< -8.0		± 0.28
	16G to 18G	< -6.0		± 0.28
	18G to 20G	< -4.0		± 0.35
1C (1B)	50M to 3G	< -17.0		± 0.43
	3G to 10G	< -11.0		± 0.37
	10G to 16G	< -8.0		± 0.28
	16G to 18G	< -6.0		± 0.28
	18G to 20G	< -4.0		± 0.35

Port (Selected Port)	Frequency Range [Hz]	Test Limit [dB]	Test Result [dB]	Measurement Uncertainty [dB]
1D (1B)	50M to 3G	< -17.0		± 0.43
	3G to 10G	< -11.0		± 0.37
	10G to 16G	< -8.0		± 0.28
	16G to 18G	< -6.0		± 0.28
	18G to 20G	< -4.0		± 0.35
1A (1C)	50M to 3G	< -17.0		± 0.43
	3G to 10G	< -11.0		± 0.37
	10G to 16G	< -8.0		± 0.28
	16G to 18G	< -6.0		± 0.28
	18G to 20G	< -4.0		± 0.35
1B (1C)	50M to 3G	< -17.0		± 0.43
	3G to 10G	< -11.0		± 0.37
	10G to 16G	< -8.0		± 0.28
	16G to 18G	< -6.0		± 0.28
	18G to 20G	< -4.0		± 0.35
1D (1C)	50M to 3G	< -17.0		± 0.43
	3G to 10G	< -11.0		± 0.37
	10G to 16G	< -8.0		± 0.28
	16G to 18G	< -6.0		± 0.28
	18G to 20G	< -4.0		± 0.35
1A (1D)	50M to 3G	< -17.0		± 0.43
	3G to 10G	< -11.0		± 0.37
	10G to 16G	< -8.0		± 0.28
	16G to 18G	< -6.0		± 0.28
	18G to 20G	< -4.0		± 0.35

Performance Tests
E5092A Performance Test Record

Port (Selected Port)	Frequency Range [Hz]	Test Limit [dB]	Test Result [dB]	Measurement Uncertainty [dB]
1B (1D)	50M to 3G	< -17.0		± 0.43
	3G to 10G	< -11.0		± 0.37
	10G to 16G	< -8.0		± 0.28
	16G to 18G	< -6.0		± 0.28
	18G to 20G	< -4.0		± 0.35
1C (1D)	50M to 3G	< -17.0		± 0.43
	3G to 10G	< -11.0		± 0.37
	10G to 16G	< -8.0		± 0.28
	16G to 18G	< -6.0		± 0.28
	18G to 20G	< -4.0		± 0.35

Load Match (Selected)

Port (Selected port)	Frequency Range [Hz]	Test Limit [dB]	Test Result [dB]	Measurement Uncertainty [dB]
1A (1A)	50M to 2G	< -17.0		± 0.37
	2G to 3G	< -11.0		± 0.28
	3G to 8G	< -8.0		± 0.18
	8G to 10G	< -7.0		± 0.28
	10G to 18G	< -4.0		± 0.29
	18G to 20G	< -4.0		± 0.29
1B (1B)	50M to 2G	< -17.0		± 0.37
	2G to 3G	< -11.0		± 0.28
	3G to 8G	< -8.0		± 0.18
	8G to 10G	< -7.0		± 0.28
	10G to 18G	< -4.0		± 0.29
	18G to 20G	< -4.0		± 0.29

Port (Selected port)	Frequency Range [Hz]	Test Limit [dB]	Test Result [dB]	Measurement Uncertainty [dB]
1C (1C)	50M to 2G	< -17.0		± 0.37
	2G to 3G	< -11.0		± 0.28
	3G to 8G	< -8.0		± 0.18
	8G to 10G	< -7.0		± 0.28
	10G to 18G	< -4.0		± 0.29
	18G to 20G	< -4.0		± 0.29
1D (1D)	50M to 2G	< -17.0		± 0.37
	2G to 3G	< -11.0		± 0.28
	3G to 8G	< -8.0		± 0.18
	8G to 10G	< -7.0		± 0.28
	10G to 18G	< -4.0		± 0.29
	18G to 20G	< -4.0		± 0.29

Load Match (COM)

Port (Selected port)	Frequency Range [Hz]	Test Limit [dB]	Test Result [dB]	Measurement Uncertainty [dB]
Port 1 (1A)	50M to 1.3G	< -16.0		± 0.30
	1.3G to 4G	< -11.0		± 0.23
	4G to 8G	< -8.0		± 0.12
	8G to 10G	< -7.0		± 0.13
	10G to 20G	< -4.0		± 0.10
Port 1 (1B)	50M to 1.3G	< -16.0		± 0.30
	1.3G to 4G	< -11.0		± 0.23
	4G to 8G	< -8.0		± 0.12
	8G to 10G	< -7.0		± 0.13
	10G to 20G	< -4.0		± 0.10

Performance Tests
E5092A Performance Test Record

Port (Selected port)	Frequency Range [Hz]	Test Limit [dB]	Test Result [dB]	Measurement Uncertainty [dB]
Port 1 (1C)	50M to 1.3G	< -16.0		± 0.30
	1.3G to 4G	< -11.0		± 0.23
	4G to 8G	< -8.0		± 0.12
	8G to 10G	< -7.0		± 0.13
	10G to 20G	< -4.0		± 0.10
Port 1 (1D)	50M to 1.3G	< -16.0		± 0.30
	1.3G to 4G	< -11.0		± 0.23
	4G to 8G	< -8.0		± 0.12
	8G to 10G	< -7.0		± 0.13
	10G to 20G	< -4.0		± 0.10

Insertion Loss

From Port - To Port	Frequency Range [Hz]	Test Limit [dB]	Test Result [dB]	Measurement Uncertainty [dB]
Port 1 - 1A	50M to 100M	> -4.0		± 0.27
	100M to 2G	> -3.5		± 0.24
	2G to 3G	> -4.5		± 0.18
	3G to 4G	> -5.5		± 0.19
	4G to 6G	> -6.0		± 0.11
	6G to 8G	> -7.5		± 0.09
	8G to 10G	> -8.5		± 0.24
	10G to 14G	> -9.5		± 0.29
	14G to 18G	> -10.5		± 0.29
	18G to 20G	> -12.0		± 0.63

From Port - To Port	Frequency Range [Hz]	Test Limit [dB]	Test Result [dB]	Measurement Uncertainty [dB]
Port 1 - 1B	50M to 100M	> -4.0		± 0.27
	100M to 2G	> -3.5		± 0.24
	2G to 3G	> -4.5		± 0.18
	3G to 4G	> -5.5		± 0.19
	4G to 6G	> -6.0		± 0.11
	6G to 8G	> -7.5		± 0.09
	8G to 10G	> -8.5		± 0.24
	10G to 14G	> -9.5		± 0.29
	14G to 18G	> -10.5		± 0.29
	18G to 20G	> -12.0		± 0.63
Port 1 - 1C	50M to 100M	> -4.0		± 0.27
	100M to 2G	> -3.5		± 0.24
	2G to 3G	> -4.5		± 0.18
	3G to 4G	> -5.5		± 0.19
	4G to 6G	> -6.0		± 0.11
	6G to 8G	> -7.5		± 0.09
	8G to 10G	> -8.5		± 0.24
	10G to 14G	> -9.5		± 0.29
	14G to 18G	> -10.5		± 0.29
	18G to 20G	> -12.0		± 0.63

Performance Tests
E5092A Performance Test Record

From Port - To Port	Frequency Range [Hz]	Test Limit [dB]	Test Result [dB]	Measurement Uncertainty [dB]
Port 1 - 1D	50M to 100M	> -4.0		± 0.27
	100M to 2G	> -3.5		± 0.24
	2G to 3G	> -4.5		± 0.18
	3G to 4G	> -5.5		± 0.19
	4G to 6G	> -6.0		± 0.11
	6G to 8G	> -7.5		± 0.09
	8G to 10G	> -8.5		± 0.24
	10G to 14G	> -9.5		± 0.29
	14G to 18G	> -10.5		± 0.29
	18G to 20G	> -12.0		± 0.63

Isolation

From Common Port To Unselected Port

From Port - To Port (Selected Port)	Frequency Range [Hz]	Test Limit [dB]	Test Result [dB]	Measurement Uncertainty [dB]
Port 1 - 1A (1B)	50M to 500M	< -65.0		± 0.35
	500M to 1G	< -80.0		± 0.48
	1G to 2G	< -85.0		± 0.60
	2G to 6G	< -90.0		± 0.76
	6G to 10G	< -85.0		± 0.66
	10G to 18G	< -75.0		± 0.54
	18G to 20G	< -65.0		± 0.43
Port 1 - 1A (1C)	50M to 500M	< -65.0		± 0.35
	500M to 1G	< -80.0		± 0.48
	1G to 2G	< -85.0		± 0.60
	2G to 6G	< -90.0		± 0.76
	6G to 10G	< -85.0		± 0.66
	10G to 18G	< -75.0		± 0.54
	18G to 20G	< -65.0		± 0.43

From Port - To Port (Selected Port)	Frequency Range [Hz]	Test Limit [dB]	Test Result [dB]	Measurement Uncertainty [dB]
Port 1 - 1A (1D)	50M to 500M	< -65.0		± 0.35
	500M to 1G	< -80.0		± 0.48
	1G to 2G	< -85.0		± 0.60
	2G to 6G	< -90.0		± 0.76
	6G to 10G	< -85.0		± 0.66
	10G to 18G	< -75.0		± 0.54
	18G to 20G	< -65.0		± 0.43
Port 1 - 1B (1A)	50M to 500M	< -65.0		± 0.35
	500M to 1G	< -80.0		± 0.48
	1G to 2G	< -85.0		± 0.60
	2G to 6G	< -90.0		± 0.76
	6G to 10G	< -85.0		± 0.66
	10G to 18G	< -75.0		± 0.54
	18G to 20G	< -65.0		± 0.43
Port 1 - 1B (1C)	50M to 500M	< -65.0		± 0.35
	500M to 1G	< -80.0		± 0.48
	1G to 2G	< -85.0		± 0.60
	2G to 6G	< -90.0		± 0.76
	6G to 10G	< -85.0		± 0.66
	10G to 18G	< -75.0		± 0.54
	18G to 20G	< -65.0		± 0.43
Port 1 - 1B (1D)	50M to 500M	< -65.0		± 0.35
	500M to 1G	< -80.0		± 0.48
	1G to 2G	< -85.0		± 0.60
	2G to 6G	< -90.0		± 0.76
	6G to 10G	< -85.0		± 0.66
	10G to 18G	< -75.0		± 0.54
	18G to 20G	< -65.0		± 0.43

Performance Tests
E5092A Performance Test Record

From Port - To Port (Selected Port)	Frequency Range [Hz]	Test Limit [dB]	Test Result [dB]	Measurement Uncertainty [dB]
Port 1 - 1C (1A)	50M to 500M	< -65.0		± 0.35
	500M to 1G	< -80.0		± 0.48
	1G to 2G	< -85.0		± 0.60
	2G to 6G	< -90.0		± 0.76
	6G to 10G	< -85.0		± 0.66
	10G to 18G	< -75.0		± 0.54
	18G to 20G	< -65.0		± 0.43
Port 1 - 1C (1B)	50M to 500M	< -65.0		± 0.35
	500M to 1G	< -80.0		± 0.48
	1G to 2G	< -85.0		± 0.60
	2G to 6G	< -90.0		± 0.76
	6G to 10G	< -85.0		± 0.66
	10G to 18G	< -75.0		± 0.54
	18G to 20G	< -65.0		± 0.43
Port 1 - 1C (1D)	50M to 500M	< -65.0		± 0.35
	500M to 1G	< -80.0		± 0.48
	1G to 2G	< -85.0		± 0.60
	2G to 6G	< -90.0		± 0.76
	6G to 10G	< -85.0		± 0.66
	10G to 18G	< -75.0		± 0.54
	18G to 20G	< -65.0		± 0.43
Port 1 - 1D (1A)	50M to 500M	< -65.0		± 0.35
	500M to 1G	< -80.0		± 0.48
	1G to 2G	< -85.0		± 0.60
	2G to 6G	< -90.0		± 0.76
	6G to 10G	< -85.0		± 0.66
	10G to 18G	< -75.0		± 0.54
	18G to 20G	< -65.0		± 0.43

From Port - To Port (Selected Port)	Frequency Range [Hz]	Test Limit [dB]	Test Result [dB]	Measurement Uncertainty [dB]
Port 1 - 1D (1B)	50M to 500M	< -65.0		± 0.35
	500M to 1G	< -80.0		± 0.48
	1G to 2G	< -85.0		± 0.60
	2G to 6G	< -90.0		± 0.76
	6G to 10G	< -85.0		± 0.66
	10G to 18G	< -75.0		± 0.54
	18G to 20G	< -65.0		± 0.43
Port 1 - 1D (1C)	50M to 500M	< -65.0		± 0.35
	500M to 1G	< -80.0		± 0.48
	1G to 2G	< -85.0		± 0.60
	2G to 6G	< -90.0		± 0.76
	6G to 10G	< -85.0		± 0.66
	10G to 18G	< -75.0		± 0.54
	18G to 20G	< -65.0		± 0.43

From Selected Port To Unselected Port

From Port - To Port (Selected Port)	Frequency Range [Hz]	Test Limit [dB]	Test Result [dB]	Measurement Uncertainty [dB]
1A - 1B (1A)	50M to 500M	< -65.0		± 0.35
	500M to 1G	< -80.0		± 0.49
	1G to 2G	< -85.0		± 0.62
	2G to 6G	< -90.0		± 0.71
	6G to 10G	< -85.0		± 0.71
	10G to 18G	< -75.0		± 0.44
	18G to 20G	< -65.0		± 0.36

Performance Tests
E5092A Performance Test Record

From Port - To Port (Selected Port)	Frequency Range [Hz]	Test Limit [dB]	Test Result [dB]	Measurement Uncertainty [dB]
1A - 1C (1A)	50M to 500M	< -65.0		± 0.35
	500M to 1G	< -80.0		± 0.49
	1G to 2G	< -85.0		± 0.62
	2G to 6G	< -90.0		± 0.71
	6G to 10G	< -85.0		± 0.71
	10G to 18G	< -75.0		± 0.44
	18G to 20G	< -65.0		± 0.36
1A - 1D (1A)	50M to 500M	< -65.0		± 0.35
	500M to 1G	< -80.0		± 0.49
	1G to 2G	< -85.0		± 0.62
	2G to 6G	< -90.0		± 0.71
	6G to 10G	< -85.0		± 0.71
	10G to 18G	< -75.0		± 0.44
	18G to 20G	< -65.0		± 0.36
1B - 1C (1B)	50M to 500M	< -65.0		± 0.35
	500M to 1G	< -80.0		± 0.49
	1G to 2G	< -85.0		± 0.62
	2G to 6G	< -90.0		± 0.71
	6G to 10G	< -85.0		± 0.71
	10G to 18G	< -75.0		± 0.44
	18G to 20G	< -65.0		± 0.36
1B- 1D (1B)	50M to 500M	< -65.0		± 0.35
	500M to 1G	< -80.0		± 0.49
	1G to 2G	< -85.0		± 0.62
	2G to 6G	< -90.0		± 0.71
	6G to 10G	< -85.0		± 0.71
	10G to 18G	< -75.0		± 0.44
	18G to 20G	< -65.0		± 0.36

From Port - To Port (Selected Port)	Frequency Range [Hz]	Test Limit [dB]	Test Result [dB]	Measurement Uncertainty [dB]
1B - 1A (1B)	50M to 500M	< -65.0		± 0.35
	500M to 1G	< -80.0		± 0.49
	1G to 2G	< -85.0		± 0.62
	2G to 6G	< -90.0		± 0.71
	6G to 10G	< -85.0		± 0.71
	10G to 18G	< -75.0		± 0.44
	18G to 20G	< -65.0		± 0.36
1C - 1D (1C)	50M to 500M	< -65.0		± 0.35
	500M to 1G	< -80.0		± 0.49
	1G to 2G	< -85.0		± 0.62
	2G to 6G	< -90.0		± 0.71
	6G to 10G	< -85.0		± 0.71
	10G to 18G	< -75.0		± 0.44
	18G to 20G	< -65.0		± 0.36
1C - 1A (1C)	50M to 500M	< -65.0		± 0.35
	500M to 1G	< -80.0		± 0.49
	1G to 2G	< -85.0		± 0.62
	2G to 6G	< -90.0		± 0.71
	6G to 10G	< -85.0		± 0.71
	10G to 18G	< -75.0		± 0.44
	18G to 20G	< -65.0		± 0.36
1C - 1B (1C)	50M to 500M	< -65.0		± 0.35
	500M to 1G	< -80.0		± 0.49
	1G to 2G	< -85.0		± 0.62
	2G to 6G	< -90.0		± 0.71
	6G to 10G	< -85.0		± 0.71
	10G to 18G	< -75.0		± 0.44
	18G to 20G	< -65.0		± 0.36

Performance Tests
E5092A Performance Test Record

From Port - To Port (Selected Port)	Frequency Range [Hz]	Test Limit [dB]	Test Result [dB]	Measurement Uncertainty [dB]
1D - 1A (1D)	50M to 500M	< -65.0		± 0.35
	500M to 1G	< -80.0		± 0.49
	1G to 2G	< -85.0		± 0.62
	2G to 6G	< -90.0		± 0.71
	6G to 10G	< -85.0		± 0.71
	10G to 18G	< -75.0		± 0.44
	18G to 20G	< -65.0		± 0.36
1D - 1B (1D)	50M to 500M	< -65.0		± 0.35
	500M to 1G	< -80.0		± 0.49
	1G to 2G	< -85.0		± 0.62
	2G to 6G	< -90.0		± 0.71
	6G to 10G	< -85.0		± 0.71
	10G to 18G	< -75.0		± 0.44
	18G to 20G	< -65.0		± 0.36
1D - 1C (1D)	50M to 500M	< -65.0		± 0.35
	500M to 1G	< -80.0		± 0.49
	1G to 2G	< -85.0		± 0.62
	2G to 6G	< -90.0		± 0.71
	6G to 10G	< -85.0		± 0.71
	10G to 18G	< -75.0		± 0.44
	18G to 20G	< -65.0		± 0.36

From Unselected Port To Unselected Port

From Port - To Port (Selected Port)	Frequency Range [Hz]	Test Limit [dB]	Test Result [dB]	Measurement Uncertainty [dB]
1B - 1C (1A)	50M to 500M	< -65.0		± 0.35
	500M to 1G	< -80.0		± 0.49
	1G to 2G	< -85.0		± 0.62
	2G to 6G	< -90.0		± 0.71
	6G to 10G	< -85.0		± 0.71
	10G to 18G	< -75.0		± 0.44
	18G to 20G	< -65.0		± 0.36
1B - 1D (1A)	50M to 500M	< -65.0		± 0.35
	500M to 1G	< -80.0		± 0.49
	1G to 2G	< -85.0		± 0.62
	2G to 6G	< -90.0		± 0.71
	6G to 10G	< -85.0		± 0.71
	10G to 18G	< -75.0		± 0.44
	18G to 20G	< -65.0		± 0.36
1C - 1D (1A)	50M to 500M	< -65.0		± 0.35
	500M to 1G	< -80.0		± 0.49
	1G to 2G	< -85.0		± 0.62
	2G to 6G	< -90.0		± 0.71
	6G to 10G	< -85.0		± 0.71
	10G to 18G	< -75.0		± 0.44
	18G to 20G	< -65.0		± 0.36
1C - 1D (1B)	50M to 500M	< -65.0		± 0.35
	500M to 1G	< -80.0		± 0.49
	1G to 2G	< -85.0		± 0.62
	2G to 6G	< -90.0		± 0.71
	6G to 10G	< -85.0		± 0.71
	10G to 18G	< -75.0		± 0.44
	18G to 20G	< -65.0		± 0.36

Performance Tests
E5092A Performance Test Record

From Port - To Port (Selected Port)	Frequency Range [Hz]	Test Limit [dB]	Test Result [dB]	Measurement Uncertainty [dB]
1C - 1A (1B)	50M to 500M	< -65.0		± 0.35
	500M to 1G	< -80.0		± 0.49
	1G to 2G	< -85.0		± 0.62
	2G to 6G	< -90.0		± 0.71
	6G to 10G	< -85.0		± 0.71
	10G to 18G	< -75.0		± 0.44
	18G to 20G	< -65.0		± 0.36
1D - 1A (1B)	50M to 500M	< -65.0		± 0.35
	500M to 1G	< -80.0		± 0.49
	1G to 2G	< -85.0		± 0.62
	2G to 6G	< -90.0		± 0.71
	6G to 10G	< -85.0		± 0.71
	10G to 18G	< -75.0		± 0.44
	18G to 20G	< -65.0		± 0.36
1D - 1A (1C)	50M to 500M	< -65.0		± 0.35
	500M to 1G	< -80.0		± 0.49
	1G to 2G	< -85.0		± 0.62
	2G to 6G	< -90.0		± 0.71
	6G to 10G	< -85.0		± 0.71
	10G to 18G	< -75.0		± 0.44
	18G to 20G	< -65.0		± 0.36
1D - 1B (1C)	50M to 500M	< -65.0		± 0.35
	500M to 1G	< -80.0		± 0.49
	1G to 2G	< -85.0		± 0.62
	2G to 6G	< -90.0		± 0.71
	6G to 10G	< -85.0		± 0.71
	10G to 18G	< -75.0		± 0.44
	18G to 20G	< -65.0		± 0.36

From Port - To Port (Selected Port)	Frequency Range [Hz]	Test Limit [dB]	Test Result [dB]	Measurement Uncertainty [dB]
1A - 1B (1C)	50M to 500M	< -65.0		± 0.35
	500M to 1G	< -80.0		± 0.49
	1G to 2G	< -85.0		± 0.62
	2G to 6G	< -90.0		± 0.71
	6G to 10G	< -85.0		± 0.71
	10G to 18G	< -75.0		± 0.44
	18G to 20G	< -65.0		± 0.36
1A - 1B (1D)	50M to 500M	< -65.0		± 0.35
	500M to 1G	< -80.0		± 0.49
	1G to 2G	< -85.0		± 0.62
	2G to 6G	< -90.0		± 0.71
	6G to 10G	< -85.0		± 0.71
	10G to 18G	< -75.0		± 0.44
	18G to 20G	< -65.0		± 0.36
1A - 1C (1D)	50M to 500M	< -65.0		± 0.35
	500M to 1G	< -80.0		± 0.49
	1G to 2G	< -85.0		± 0.62
	2G to 6G	< -90.0		± 0.71
	6G to 10G	< -85.0		± 0.71
	10G to 18G	< -75.0		± 0.44
	18G to 20G	< -65.0		± 0.36
1B - 1C (1D)	50M to 500M	< -65.0		± 0.35
	500M to 1G	< -80.0		± 0.49
	1G to 2G	< -85.0		± 0.62
	2G to 6G	< -90.0		± 0.71
	6G to 10G	< -85.0		± 0.71
	10G to 18G	< -75.0		± 0.44
	18G to 20G	< -65.0		± 0.36

Performance Tests
E5092A Performance Test Record

Load Match, Insertion Loss and Isolation Test for Switch 2(SP4T, Port 2, 2A, 2B, 2C and 2D)

Load Match (Unselected)

Port (Selected Port)	Frequency Range [Hz]	Test Limit [dB]	Test Result [dB]	Measurement Uncertainty [dB]
2B (2A)	50M to 3G	< -17.0		± 0.43
	3G to 10G	< -11.0		± 0.37
	10G to 16G	< -8.0		± 0.28
	16G to 18G	< -6.0		± 0.28
	18G to 20G	< -4.0		± 0.35
2C (2A)	50M to 3G	< -17.0		± 0.43
	3G to 10G	< -11.0		± 0.37
	10G to 16G	< -8.0		± 0.28
	16G to 18G	< -6.0		± 0.28
	18G to 20G	< -4.0		± 0.35
2D (2A)	50M to 3G	< -17.0		± 0.43
	3G to 10G	< -11.0		± 0.37
	10G to 16G	< -8.0		± 0.28
	16G to 18G	< -6.0		± 0.28
	18G to 20G	< -4.0		± 0.35
2A (2B)	50M to 3G	< -17.0		± 0.43
	3G to 10G	< -11.0		± 0.37
	10G to 16G	< -8.0		± 0.28
	16G to 18G	< -6.0		± 0.28
	18G to 20G	< -4.0		± 0.35
2C (2B)	50M to 3G	< -17.0		± 0.43
	3G to 10G	< -11.0		± 0.37
	10G to 16G	< -8.0		± 0.28
	16G to 18G	< -6.0		± 0.28
	18G to 20G	< -4.0		± 0.35

Port (Selected Port)	Frequency Range [Hz]	Test Limit [dB]	Test Result [dB]	Measurement Uncertainty [dB]
2D (2B)	50M to 3G	< -17.0		± 0.43
	3G to 10G	< -11.0		± 0.37
	10G to 16G	< -8.0		± 0.28
	16G to 18G	< -6.0		± 0.28
	18G to 20G	< -4.0		± 0.35
2A (2C)	50M to 3G	< -17.0		± 0.43
	3G to 10G	< -11.0		± 0.37
	10G to 16G	< -8.0		± 0.28
	16G to 18G	< -6.0		± 0.28
	18G to 20G	< -4.0		± 0.35
2B (2C)	50M to 3G	< -17.0		± 0.43
	3G to 10G	< -11.0		± 0.37
	10G to 16G	< -8.0		± 0.28
	16G to 18G	< -6.0		± 0.28
	18G to 20G	< -4.0		± 0.35
2D (2C)	50M to 3G	< -17.0		± 0.43
	3G to 10G	< -11.0		± 0.37
	10G to 16G	< -8.0		± 0.28
	16G to 18G	< -6.0		± 0.28
	18G to 20G	< -4.0		± 0.35
2A (2D)	50M to 3G	< -17.0		± 0.43
	3G to 10G	< -11.0		± 0.37
	10G to 16G	< -8.0		± 0.28
	16G to 18G	< -6.0		± 0.28
	18G to 20G	< -4.0		± 0.35

Performance Tests
E5092A Performance Test Record

Port (Selected Port)	Frequency Range [Hz]	Test Limit [dB]	Test Result [dB]	Measurement Uncertainty [dB]
2B (2D)	50M to 3G	< -17.0		± 0.43
	3G to 10G	< -11.0		± 0.37
	10G to 16G	< -8.0		± 0.28
	16G to 18G	< -6.0		± 0.28
	18G to 20G	< -4.0		± 0.35
2C (2D)	50M to 3G	< -17.0		± 0.43
	3G to 10G	< -11.0		± 0.37
	10G to 16G	< -8.0		± 0.28
	16G to 18G	< -6.0		± 0.28
	18G to 20G	< -4.0		± 0.35

Load Match (Selected)

Port (Selected Port)	Frequency Range [Hz]	Test Limit [dB]	Test Result [dB]	Measurement Uncertainty [dB]
2A (2A)	50M to 2G	< -17.0		± 0.37
	2G to 3G	< -11.0		± 0.28
	3G to 8G	< -8.0		± 0.18
	8G to 10G	< -7.0		± 0.28
	10G to 18G	< -4.0		± 0.29
	18G to 20G	< -4.0		± 0.29
2B (2B)	50M to 2G	< -17.0		± 0.37
	2G to 3G	< -11.0		± 0.28
	3G to 8G	< -8.0		± 0.18
	8G to 10G	< -7.0		± 0.28
	10G to 18G	< -4.0		± 0.29
	18G to 20G	< -4.0		± 0.29

Port (Selected Port)	Frequency Range [Hz]	Test Limit [dB]	Test Result [dB]	Measurement Uncertainty [dB]
2C (2C)	50M to 2G	< -17.0		± 0.37
	2G to 3G	< -11.0		± 0.28
	3G to 8G	< -8.0		± 0.18
	8G to 10G	< -7.0		± 0.28
	10G to 18G	< -4.0		± 0.29
	18G to 20G	< -4.0		± 0.29
2D (2D)	50M to 2G	< -17.0		± 0.37
	2G to 3G	< -11.0		± 0.28
	3G to 8G	< -8.0		± 0.18
	8G to 10G	< -7.0		± 0.28
	10G to 18G	< -4.0		± 0.29
	18G to 20G	< -4.0		± 0.29

Load Match (COM)

Port (Selected Port)	Frequency Range [Hz]	Test Limit [dB]	Test Result [dB]	Measurement Uncertainty [dB]
Port 2 (2A)	50M to 1.3G	< -16.0		± 0.30
	1.3G to 4G	< -11.0		± 0.23
	4G to 8G	< -8.0		± 0.12
	8G to 10G	< -7.0		± 0.13
	10G to 20G	< -4.0		± 0.10
Port 2 (2B)	50M to 1.3G	< -16.0		± 0.30
	1.3G to 4G	< -11.0		± 0.23
	4G to 8G	< -8.0		± 0.12
	8G to 10G	< -7.0		± 0.13
	10G to 20G	< -4.0		± 0.10

Performance Tests
E5092A Performance Test Record

Port (Selected Port)	Frequency Range [Hz]	Test Limit [dB]	Test Result [dB]	Measurement Uncertainty [dB]
Port 2 (2C)	50M to 1.3G	< -16.0		± 0.30
	1.3G to 4G	< -11.0		± 0.23
	4G to 8G	< -8.0		± 0.12
	8G to 10G	< -7.0		± 0.13
	10G to 20G	< -4.0		± 0.10
Port 2 (2D)	50M to 1.3G	< -16.0		± 0.30
	1.3G to 4G	< -11.0		± 0.23
	4G to 8G	< -8.0		± 0.12
	8G to 10G	< -7.0		± 0.13
	10G to 20G	< -4.0		± 0.10

Insertion Loss

From Port - To Port	Frequency Range [Hz]	Test Limit [dB]	Test Result [dB]	Measurement Uncertainty [dB]
Port 2 - 2A	50M to 100M	> -4.0		± 0.27
	100M to 2G	> -3.5		± 0.24
	2G to 3G	> -4.5		± 0.18
	3G to 4G	> -5.5		± 0.19
	4G to 6G	> -6.0		± 0.11
	6G to 8G	> -7.5		± 0.09
	8G to 10G	> -8.5		± 0.24
	10G to 14G	> -9.5		± 0.29
	14G to 18G	> -10.5		± 0.29
	18G to 20G	> -12.0		± 0.63

From Port - To Port	Frequency Range [Hz]	Test Limit [dB]	Test Result [dB]	Measurement Uncertainty [dB]
Port 2 - 2B	50M to 100M	> -4.0		± 0.27
	100M to 2G	> -3.5		± 0.24
	2G to 3G	> -4.5		± 0.18
	3G to 4G	> -5.5		± 0.19
	4G to 6G	> -6.0		± 0.11
	6G to 8G	> -7.5		± 0.09
	8G to 10G	> -8.5		± 0.24
	10G to 14G	> -9.5		± 0.29
	14G to 18G	> -10.5		± 0.29
	18G to 20G	> -12.0		± 0.63
Port 2 - 2C	50M to 100M	> -4.0		± 0.27
	100M to 2G	> -3.5		± 0.24
	2G to 3G	> -4.5		± 0.18
	3G to 4G	> -5.5		± 0.19
	4G to 6G	> -6.0		± 0.11
	6G to 8G	> -7.5		± 0.09
	8G to 10G	> -8.5		± 0.24
	10G to 14G	> -9.5		± 0.29
	14G to 18G	> -10.5		± 0.29
	18G to 20G	> -12.0		± 0.63

Performance Tests
E5092A Performance Test Record

From Port - To Port	Frequency Range [Hz]	Test Limit [dB]	Test Result [dB]	Measurement Uncertainty [dB]
Port 2 - 2D	50M to 100M	> -4.0		± 0.27
	100M to 2G	> -3.5		± 0.24
	2G to 3G	> -4.5		± 0.18
	3G to 4G	> -5.5		± 0.19
	4G to 6G	> -6.0		± 0.11
	6G to 8G	> -7.5		± 0.09
	8G to 10G	> -8.5		± 0.24
	10G to 14G	> -9.5		± 0.29
	14G to 18G	> -10.5		± 0.29
	18G to 20G	> -12.0		± 0.63

Isolation

From Common Port To Unselected Port

Port - To Port (Selected Port)	Frequency Range [Hz]	Test Limit [dB]	Test Result [dB]	Measurement Uncertainty [dB]
Port 2 - 2A (2B)	50M to 500M	< -65.0		± 0.35
	500M to 1G	< -80.0		± 0.48
	1G to 2G	< -85.0		± 0.60
	2G to 6G	< -90.0		± 0.76
	6G to 10G	< -85.0		± 0.66
	10G to 18G	< -75.0		± 0.54
	18G to 20G	< -65.0		± 0.43
Port 2 - 2A (2C)	50M to 500M	< -65.0		± 0.35
	500M to 1G	< -80.0		± 0.48
	1G to 2G	< -85.0		± 0.60
	2G to 6G	< -90.0		± 0.76
	6G to 10G	< -85.0		± 0.66
	10G to 18G	< -75.0		± 0.54
	18G to 20G	< -65.0		± 0.43

Port - To Port (Selected Port)	Frequency Range [Hz]	Test Limit [dB]	Test Result [dB]	Measurement Uncertainty [dB]
Port 2 - 2A (2D)	50M to 500M	< -65.0		± 0.35
	500M to 1G	< -80.0		± 0.48
	1G to 2G	< -85.0		± 0.60
	2G to 6G	< -90.0		± 0.76
	6G to 10G	< -85.0		± 0.66
	10G to 18G	< -75.0		± 0.54
	18G to 20G	< -65.0		± 0.43
Port 2 - 2B (2A)	50M to 500M	< -65.0		± 0.35
	500M to 1G	< -80.0		± 0.48
	1G to 2G	< -85.0		± 0.60
	2G to 6G	< -90.0		± 0.76
	6G to 10G	< -85.0		± 0.66
	10G to 18G	< -75.0		± 0.54
	18G to 20G	< -65.0		± 0.43
Port 2 - 2B (2C)	50M to 500M	< -65.0		± 0.35
	500M to 1G	< -80.0		± 0.48
	1G to 2G	< -85.0		± 0.60
	2G to 6G	< -90.0		± 0.76
	6G to 10G	< -85.0		± 0.66
	10G to 18G	< -75.0		± 0.54
	18G to 20G	< -65.0		± 0.43
Port 2 - 2B (2D)	50M to 500M	< -65.0		± 0.35
	500M to 1G	< -80.0		± 0.48
	1G to 2G	< -85.0		± 0.60
	2G to 6G	< -90.0		± 0.76
	6G to 10G	< -85.0		± 0.66
	10G to 18G	< -75.0		± 0.54
	18G to 20G	< -65.0		± 0.43

Performance Tests
E5092A Performance Test Record

Port - To Port (Selected Port)	Frequency Range [Hz]	Test Limit [dB]	Test Result [dB]	Measurement Uncertainty [dB]
Port 2 - 2C (2A)	50M to 500M	< -65.0		± 0.35
	500M to 1G	< -80.0		± 0.48
	1G to 2G	< -85.0		± 0.60
	2G to 6G	< -90.0		± 0.76
	6G to 10G	< -85.0		± 0.66
	10G to 18G	< -75.0		± 0.54
	18G to 20G	< -65.0		± 0.43
Port 2 - 2C (2B)	50M to 500M	< -65.0		± 0.35
	500M to 1G	< -80.0		± 0.48
	1G to 2G	< -85.0		± 0.60
	2G to 6G	< -90.0		± 0.76
	6G to 10G	< -85.0		± 0.66
	10G to 18G	< -75.0		± 0.54
	18G to 20G	< -65.0		± 0.43
Port 2 - 2C (2D)	50M to 500M	< -65.0		± 0.35
	500M to 1G	< -80.0		± 0.48
	1G to 2G	< -85.0		± 0.60
	2G to 6G	< -90.0		± 0.76
	6G to 10G	< -85.0		± 0.66
	10G to 18G	< -75.0		± 0.54
	18G to 20G	< -65.0		± 0.43
Port 2 - 2D (2A)	50M to 500M	< -65.0		± 0.35
	500M to 1G	< -80.0		± 0.48
	1G to 2G	< -85.0		± 0.60
	2G to 6G	< -90.0		± 0.76
	6G to 10G	< -85.0		± 0.66
	10G to 18G	< -75.0		± 0.54
	18G to 20G	< -65.0		± 0.43

Port - To Port (Selected Port)	Frequency Range [Hz]	Test Limit [dB]	Test Result [dB]	Measurement Uncertainty [dB]
Port 2 - 2D (2B)	50M to 500M	< -65.0		± 0.35
	500M to 1G	< -80.0		± 0.48
	1G to 2G	< -85.0		± 0.60
	2G to 6G	< -90.0		± 0.76
	6G to 10G	< -85.0		± 0.66
	10G to 18G	< -75.0		± 0.54
	18G to 20G	< -65.0		± 0.43
Port 2 - 2D (2C)	50M to 500M	< -65.0		± 0.35
	500M to 1G	< -80.0		± 0.48
	1G to 2G	< -85.0		± 0.60
	2G to 6G	< -90.0		± 0.76
	6G to 10G	< -85.0		± 0.66
	10G to 18G	< -75.0		± 0.54
	18G to 20G	< -65.0		± 0.43

From Selected Port To Unselected Port

From Port - To Port (Selected Port)	Frequency Range [Hz]	Test Limit [dB]	Test Result [dB]	Measurement Uncertainty [dB]
2A - 2B (2A)	50M to 500M	< -65.0		± 0.35
	500M to 1G	< -80.0		± 0.49
	1G to 2G	< -85.0		± 0.62
	2G to 6G	< -90.0		± 0.71
	6G to 10G	< -85.0		± 0.71
	10G to 18G	< -75.0		± 0.44
	18G to 20G	< -65.0		± 0.36

Performance Tests
E5092A Performance Test Record

From Port - To Port (Selected Port)	Frequency Range [Hz]	Test Limit [dB]	Test Result [dB]	Measurement Uncertainty [dB]
2A - 2C (2A)	50M to 500M	< -65.0		± 0.35
	500M to 1G	< -80.0		± 0.49
	1G to 2G	< -85.0		± 0.62
	2G to 6G	< -90.0		± 0.71
	6G to 10G	< -85.0		± 0.71
	10G to 18G	< -75.0		± 0.44
	18G to 20G	< -65.0		± 0.36
2A - 2D (2A)	50M to 500M	< -65.0		± 0.35
	500M to 1G	< -80.0		± 0.49
	1G to 2G	< -85.0		± 0.62
	2G to 6G	< -90.0		± 0.71
	6G to 10G	< -85.0		± 0.71
	10G to 18G	< -75.0		± 0.44
	18G to 20G	< -65.0		± 0.36
2B - 2C (2B)	50M to 500M	< -65.0		± 0.35
	500M to 1G	< -80.0		± 0.49
	1G to 2G	< -85.0		± 0.62
	2G to 6G	< -90.0		± 0.71
	6G to 10G	< -85.0		± 0.71
	10G to 18G	< -75.0		± 0.44
	18G to 20G	< -65.0		± 0.36
2B- 2D (2B)	50M to 500M	< -65.0		± 0.35
	500M to 1G	< -80.0		± 0.49
	1G to 2G	< -85.0		± 0.62
	2G to 6G	< -90.0		± 0.71
	6G to 10G	< -85.0		± 0.71
	10G to 18G	< -75.0		± 0.44
	18G to 20G	< -65.0		± 0.36

From Port - To Port (Selected Port)	Frequency Range [Hz]	Test Limit [dB]	Test Result [dB]	Measurement Uncertainty [dB]
2B - 2A (2B)	50M to 500M	< -65.0		± 0.35
	500M to 1G	< -80.0		± 0.49
	1G to 2G	< -85.0		± 0.62
	2G to 6G	< -90.0		± 0.71
	6G to 10G	< -85.0		± 0.71
	10G to 18G	< -75.0		± 0.44
	18G to 20G	< -65.0		± 0.36
2C - 2D (2C)	50M to 500M	< -65.0		± 0.35
	500M to 1G	< -80.0		± 0.49
	1G to 2G	< -85.0		± 0.62
	2G to 6G	< -90.0		± 0.71
	6G to 10G	< -85.0		± 0.71
	10G to 18G	< -75.0		± 0.44
	18G to 20G	< -65.0		± 0.36
2C - 2A (2C)	50M to 500M	< -65.0		± 0.35
	500M to 1G	< -80.0		± 0.49
	1G to 2G	< -85.0		± 0.62
	2G to 6G	< -90.0		± 0.71
	6G to 10G	< -85.0		± 0.71
	10G to 18G	< -75.0		± 0.44
	18G to 20G	< -65.0		± 0.36
2C - 2B (2C)	50M to 500M	< -65.0		± 0.35
	500M to 1G	< -80.0		± 0.49
	1G to 2G	< -85.0		± 0.62
	2G to 6G	< -90.0		± 0.71
	6G to 10G	< -85.0		± 0.71
	10G to 18G	< -75.0		± 0.44
	18G to 20G	< -65.0		± 0.36

Performance Tests
E5092A Performance Test Record

From Port - To Port (Selected Port)	Frequency Range [Hz]	Test Limit [dB]	Test Result [dB]	Measurement Uncertainty [dB]
2D - 2A (2D)	50M to 500M	< -65.0		± 0.35
	500M to 1G	< -80.0		± 0.49
	1G to 2G	< -85.0		± 0.62
	2G to 6G	< -90.0		± 0.71
	6G to 10G	< -85.0		± 0.71
	10G to 18G	< -75.0		± 0.44
	18G to 20G	< -65.0		± 0.36
2D - 2B (2D)	50M to 500M	< -65.0		± 0.35
	500M to 1G	< -80.0		± 0.49
	1G to 2G	< -85.0		± 0.62
	2G to 6G	< -90.0		± 0.71
	6G to 10G	< -85.0		± 0.71
	10G to 18G	< -75.0		± 0.44
	18G to 20G	< -65.0		± 0.36
2D - 2C (2D)	50M to 500M	< -65.0		± 0.35
	500M to 1G	< -80.0		± 0.49
	1G to 2G	< -85.0		± 0.62
	2G to 6G	< -90.0		± 0.71
	6G to 10G	< -85.0		± 0.71
	10G to 18G	< -75.0		± 0.44
	18G to 20G	< -65.0		± 0.36

From Unselected Port To Unselected Port

From Port - To Port (Selected Port)	Frequency Range [Hz]	Test Limit [dB]	Test Result [dB]	Measurement Uncertainty [dB]
2B - 2C (2A)	50M to 500M	< -65.0		± 0.35
	500M to 1G	< -80.0		± 0.49
	1G to 2G	< -85.0		± 0.62
	2G to 6G	< -90.0		± 0.71
	6G to 10G	< -85.0		± 0.71
	10G to 18G	< -75.0		± 0.44
	18G to 20G	< -65.0		± 0.36
2B - 2D (2A)	50M to 500M	< -65.0		± 0.35
	500M to 1G	< -80.0		± 0.49
	1G to 2G	< -85.0		± 0.62
	2G to 6G	< -90.0		± 0.71
	6G to 10G	< -85.0		± 0.71
	10G to 18G	< -75.0		± 0.44
	18G to 20G	< -65.0		± 0.36
2C - 2D (2A)	50M to 500M	< -65.0		± 0.35
	500M to 1G	< -80.0		± 0.49
	1G to 2G	< -85.0		± 0.62
	2G to 6G	< -90.0		± 0.71
	6G to 10G	< -85.0		± 0.71
	10G to 18G	< -75.0		± 0.44
	18G to 20G	< -65.0		± 0.36
2C - 2D (2B)	50M to 500M	< -65.0		± 0.35
	500M to 1G	< -80.0		± 0.49
	1G to 2G	< -85.0		± 0.62
	2G to 6G	< -90.0		± 0.71
	6G to 10G	< -85.0		± 0.71
	10G to 18G	< -75.0		± 0.44
	18G to 20G	< -65.0		± 0.36

Performance Tests
E5092A Performance Test Record

From Port - To Port (Selected Port)	Frequency Range [Hz]	Test Limit [dB]	Test Result [dB]	Measurement Uncertainty [dB]
2C - 2A (2B)	50M to 500M	< -65.0		± 0.35
	500M to 1G	< -80.0		± 0.49
	1G to 2G	< -85.0		± 0.62
	2G to 6G	< -90.0		± 0.71
	6G to 10G	< -85.0		± 0.71
	10G to 18G	< -75.0		± 0.44
	18G to 20G	< -65.0		± 0.36
2D - 2A (2B)	50M to 500M	< -65.0		± 0.35
	500M to 1G	< -80.0		± 0.49
	1G to 2G	< -85.0		± 0.62
	2G to 6G	< -90.0		± 0.71
	6G to 10G	< -85.0		± 0.71
	10G to 18G	< -75.0		± 0.44
	18G to 20G	< -65.0		± 0.36
2D - 2A (2C)	50M to 500M	< -65.0		± 0.35
	500M to 1G	< -80.0		± 0.49
	1G to 2G	< -85.0		± 0.62
	2G to 6G	< -90.0		± 0.71
	6G to 10G	< -85.0		± 0.71
	10G to 18G	< -75.0		± 0.44
	18G to 20G	< -65.0		± 0.36
2D - 2B (2C)	50M to 500M	< -65.0		± 0.35
	500M to 1G	< -80.0		± 0.49
	1G to 2G	< -85.0		± 0.62
	2G to 6G	< -90.0		± 0.71
	6G to 10G	< -85.0		± 0.71
	10G to 18G	< -75.0		± 0.44
	18G to 20G	< -65.0		± 0.36

From Port - To Port (Selected Port)	Frequency Range [Hz]	Test Limit [dB]	Test Result [dB]	Measurement Uncertainty [dB]
2A - 2B (2C)	50M to 500M	< -65.0		± 0.35
	500M to 1G	< -80.0		± 0.49
	1G to 2G	< -85.0		± 0.62
	2G to 6G	< -90.0		± 0.71
	6G to 10G	< -85.0		± 0.71
	10G to 18G	< -75.0		± 0.44
	18G to 20G	< -65.0		± 0.36
2A - 2B (2D)	50M to 500M	< -65.0		± 0.35
	500M to 1G	< -80.0		± 0.49
	1G to 2G	< -85.0		± 0.62
	2G to 6G	< -90.0		± 0.71
	6G to 10G	< -85.0		± 0.71
	10G to 18G	< -75.0		± 0.44
	18G to 20G	< -65.0		± 0.36
2A - 2C (2D)	50M to 500M	< -65.0		± 0.35
	500M to 1G	< -80.0		± 0.49
	1G to 2G	< -85.0		± 0.62
	2G to 6G	< -90.0		± 0.71
	6G to 10G	< -85.0		± 0.71
	10G to 18G	< -75.0		± 0.44
	18G to 20G	< -65.0		± 0.36
2B - 2C (2D)	50M to 500M	< -65.0		± 0.35
	500M to 1G	< -80.0		± 0.49
	1G to 2G	< -85.0		± 0.62
	2G to 6G	< -90.0		± 0.71
	6G to 10G	< -85.0		± 0.71
	10G to 18G	< -75.0		± 0.44
	18G to 20G	< -65.0		± 0.36

Performance Tests
E5092A Performance Test Record

Load Match, Insertion Loss and Isolation Test for Switch 3 (SP4T, Port 3, 3A, 3B, 3C and 3D)

Load Match (Unselected)

Port (Selected Port)	Frequency Range [Hz]	Test Limit [dB]	Test Result [dB]	Measurement Uncertainty [dB]
3B (3A)	50M to 3G	< -17.0		± 0.43
	3G to 10G	< -11.0		± 0.37
	10G to 16G	< -8.0		± 0.28
	16G to 18G	< -6.0		± 0.28
	18G to 20G	< -4.0		± 0.35
3C (3A)	50M to 3G	< -17.0		± 0.43
	3G to 10G	< -11.0		± 0.37
	10G to 16G	< -8.0		± 0.28
	16G to 18G	< -6.0		± 0.28
	18G to 20G	< -4.0		± 0.35
3D (3A)	50M to 3G	< -17.0		± 0.43
	3G to 10G	< -11.0		± 0.37
	10G to 16G	< -8.0		± 0.28
	16G to 18G	< -6.0		± 0.28
	18G to 20G	< -4.0		± 0.35
3A (3B)	50M to 3G	< -17.0		± 0.43
	3G to 10G	< -11.0		± 0.37
	10G to 16G	< -8.0		± 0.28
	16G to 18G	< -6.0		± 0.28
	18G to 20G	< -4.0		± 0.35
3C (3B)	50M to 3G	< -17.0		± 0.43
	3G to 10G	< -11.0		± 0.37
	10G to 16G	< -8.0		± 0.28
	16G to 18G	< -6.0		± 0.28
	18G to 20G	< -4.0		± 0.35

Port (Selected Port)	Frequency Range [Hz]	Test Limit [dB]	Test Result [dB]	Measurement Uncertainty [dB]
3D (3B)	50M to 3G	< -17.0		± 0.43
	3G to 10G	< -11.0		± 0.37
	10G to 16G	< -8.0		± 0.28
	16G to 18G	< -6.0		± 0.28
	18G to 20G	< -4.0		± 0.35
3A (3C)	50M to 3G	< -17.0		± 0.43
	3G to 10G	< -11.0		± 0.37
	10G to 16G	< -8.0		± 0.28
	16G to 18G	< -6.0		± 0.28
	18G to 20G	< -4.0		± 0.35
3B (3C)	50M to 3G	< -17.0		± 0.43
	3G to 10G	< -11.0		± 0.37
	10G to 16G	< -8.0		± 0.28
	16G to 18G	< -6.0		± 0.28
	18G to 20G	< -4.0		± 0.35
3D (3C)	50M to 3G	< -17.0		± 0.43
	3G to 10G	< -11.0		± 0.37
	10G to 16G	< -8.0		± 0.28
	16G to 18G	< -6.0		± 0.28
	18G to 20G	< -4.0		± 0.35
3A (3D)	50M to 3G	< -17.0		± 0.43
	3G to 10G	< -11.0		± 0.37
	10G to 16G	< -8.0		± 0.28
	16G to 18G	< -6.0		± 0.28
	18G to 20G	< -4.0		± 0.35

Performance Tests
E5092A Performance Test Record

Port (Selected Port)	Frequency Range [Hz]	Test Limit [dB]	Test Result [dB]	Measurement Uncertainty [dB]
3B (3D)	50M to 3G	< -17.0		± 0.43
	3G to 10G	< -11.0		± 0.37
	10G to 16G	< -8.0		± 0.28
	16G to 18G	< -6.0		± 0.28
	18G to 20G	< -4.0		± 0.35
3C (3D)	50M to 3G	< -17.0		± 0.43
	3G to 10G	< -11.0		± 0.37
	10G to 16G	< -8.0		± 0.28
	16G to 18G	< -6.0		± 0.28
	18G to 20G	< -4.0		± 0.35

Load Match (Selected)

Port (Selected Port)	Frequency Range [Hz]	Test Limit [dB]	Test Result [dB]	Measurement Uncertainty [dB]
3A (3A)	50M to 2G	< -17.0		± 0.37
	2G to 3G	< -11.0		± 0.28
	3G to 8G	< -8.0		± 0.18
	8G to 10G	< -7.0		± 0.28
	10G to 18G	< -4.0		± 0.29
	18G to 20G	< -4.0		± 0.29
3B (3B)	50M to 2G	< -17.0		± 0.37
	2G to 3G	< -11.0		± 0.28
	3G to 8G	< -8.0		± 0.18
	8G to 10G	< -7.0		± 0.28
	10G to 18G	< -4.0		± 0.29
	18G to 20G	< -4.0		± 0.29

Port (Selected Port)	Frequency Range [Hz]	Test Limit [dB]	Test Result [dB]	Measurement Uncertainty [dB]
3C (3C)	50M to 2G	< -17.0		± 0.37
	2G to 3G	< -11.0		± 0.28
	3G to 8G	< -8.0		± 0.18
	8G to 10G	< -7.0		± 0.28
	10G to 18G	< -4.0		± 0.29
	18G to 20G	< -4.0		± 0.29
3D (3D)	50M to 2G	< -17.0		± 0.37
	2G to 3G	< -11.0		± 0.28
	3G to 8G	< -8.0		± 0.18
	8G to 10G	< -7.0		± 0.28
	10G to 18G	< -4.0		± 0.29
	18G to 20G	< -4.0		± 0.29

Load Match (COM)

Port (Selected Port)	Frequency Range [Hz]	Test Limit [dB]	Test Result [dB]	Measurement Uncertainty [dB]
Port 3 (3A)	50M to 1.3G	< -16.0		± 0.30
	1.3G to 4G	< -11.0		± 0.23
	4G to 8G	< -8.0		± 0.12
	8G to 10G	< -7.0		± 0.13
	10G to 20G	< -4.0		± 0.10
Port 3 (3B)	50M to 1.3G	< -16.0		± 0.30
	1.3G to 4G	< -11.0		± 0.23
	4G to 8G	< -8.0		± 0.12
	8G to 10G	< -7.0		± 0.13
	10G to 20G	< -4.0		± 0.10

Performance Tests
E5092A Performance Test Record

Port (Selected Port)	Frequency Range [Hz]	Test Limit [dB]	Test Result [dB]	Measurement Uncertainty [dB]
Port 3 (3C)	50M to 1.3G	< -16.0		± 0.30
	1.3G to 4G	< -11.0		± 0.23
	4G to 8G	< -8.0		± 0.12
	8G to 10G	< -7.0		± 0.13
	10G to 20G	< -4.0		± 0.10
Port 3 (3D)	50M to 1.3G	< -16.0		± 0.30
	1.3G to 4G	< -11.0		± 0.23
	4G to 8G	< -8.0		± 0.12
	8G to 10G	< -7.0		± 0.13
	10G to 20G	< -4.0		± 0.10

Insertion Loss

From Port - To Port	Frequency Range [Hz]	Test Limit [dB]	Test Result [dB]	Measurement Uncertainty [dB]
Port 3 - 3A	50M to 100M	> -4.0		± 0.27
	100M to 2G	> -3.5		± 0.24
	2G to 3G	> -4.5		± 0.18
	3G to 4G	> -5.5		± 0.19
	4G to 6G	> -6.0		± 0.11
	6G to 8G	> -7.5		± 0.09
	8G to 10G	> -8.5		± 0.24
	10G to 14G	> -9.5		± 0.29
	14G to 18G	> -10.5		± 0.29
	18G to 20G	> -12.0		± 0.63

From Port - To Port	Frequency Range [Hz]	Test Limit [dB]	Test Result [dB]	Measurement Uncertainty [dB]
Port 3 - 3B	50M to 100M	> -4.0		± 0.27
	100M to 2G	> -3.5		± 0.24
	2G to 3G	> -4.5		± 0.18
	3G to 4G	> -5.5		± 0.19
	4G to 6G	> -6.0		± 0.11
	6G to 8G	> -7.5		± 0.09
	8G to 10G	> -8.5		± 0.24
	10G to 14G	> -9.5		± 0.29
	14G to 18G	> -10.5		± 0.29
	18G to 20G	> -12.0		± 0.63
Port 3 - 3C	50M to 100M	> -4.0		± 0.27
	100M to 2G	> -3.5		± 0.24
	2G to 3G	> -4.5		± 0.18
	3G to 4G	> -5.5		± 0.19
	4G to 6G	> -6.0		± 0.11
	6G to 8G	> -7.5		± 0.09
	8G to 10G	> -8.5		± 0.24
	10G to 14G	> -9.5		± 0.29
	14G to 18G	> -10.5		± 0.29
	18G to 20G	> -12.0		± 0.63

Performance Tests
E5092A Performance Test Record

From Port - To Port	Frequency Range [Hz]	Test Limit [dB]	Test Result [dB]	Measurement Uncertainty [dB]
Port 3 - 3D	50M to 100M	> -4.0		± 0.27
	100M to 2G	> -3.5		± 0.24
	2G to 3G	> -4.5		± 0.18
	3G to 4G	> -5.5		± 0.19
	4G to 6G	> -6.0		± 0.11
	6G to 8G	> -7.5		± 0.09
	8G to 10G	> -8.5		± 0.24
	10G to 14G	> -9.5		± 0.29
	14G to 18G	> -10.5		± 0.29
	18G to 20G	> -12.0		± 0.63

Isolation

From Common Port To Unselected Port

Port - To Port (Selected Port)	Frequency Range [Hz]	Test Limit [dB]	Test Result [dB]	Measurement Uncertainty [dB]
Port 3 - 3A (3B)	50M to 500M	< -65.0		± 0.35
	500M to 1G	< -80.0		± 0.48
	1G to 2G	< -85.0		± 0.60
	2G to 6G	< -90.0		± 0.76
	6G to 10G	< -85.0		± 0.66
	10G to 18G	< -75.0		± 0.54
	18G to 20G	< -65.0		± 0.43
Port 3 - 3A (3C)	50M to 500M	< -65.0		± 0.35
	500M to 1G	< -80.0		± 0.48
	1G to 2G	< -85.0		± 0.60
	2G to 6G	< -90.0		± 0.76
	6G to 10G	< -85.0		± 0.66
	10G to 18G	< -75.0		± 0.54
	18G to 20G	< -65.0		± 0.43

Port - To Port (Selected Port)	Frequency Range [Hz]	Test Limit [dB]	Test Result [dB]	Measurement Uncertainty [dB]
Port 3 - 3A (3D)	50M to 500M	< -65.0		± 0.35
	500M to 1G	< -80.0		± 0.48
	1G to 2G	< -85.0		± 0.60
	2G to 6G	< -90.0		± 0.76
	6G to 10G	< -85.0		± 0.66
	10G to 18G	< -75.0		± 0.54
	18G to 20G	< -65.0		± 0.43
Port 3 - 3B (3A)	50M to 500M	< -65.0		± 0.35
	500M to 1G	< -80.0		± 0.48
	1G to 2G	< -85.0		± 0.60
	2G to 6G	< -90.0		± 0.76
	6G to 10G	< -85.0		± 0.66
	10G to 18G	< -75.0		± 0.54
	18G to 20G	< -65.0		± 0.43
Port 3 - 3B (3C)	50M to 500M	< -65.0		± 0.35
	500M to 1G	< -80.0		± 0.48
	1G to 2G	< -85.0		± 0.60
	2G to 6G	< -90.0		± 0.76
	6G to 10G	< -85.0		± 0.66
	10G to 18G	< -75.0		± 0.54
	18G to 20G	< -65.0		± 0.43
Port 3 - 3B (3D)	50M to 500M	< -65.0		± 0.35
	500M to 1G	< -80.0		± 0.48
	1G to 2G	< -85.0		± 0.60
	2G to 6G	< -90.0		± 0.76
	6G to 10G	< -85.0		± 0.66
	10G to 18G	< -75.0		± 0.54
	18G to 20G	< -65.0		± 0.43

Performance Tests
E5092A Performance Test Record

Port - To Port (Selected Port)	Frequency Range [Hz]	Test Limit [dB]	Test Result [dB]	Measurement Uncertainty [dB]
Port 3 - 3C (3A)	50M to 500M	< -65.0		± 0.35
	500M to 1G	< -80.0		± 0.48
	1G to 2G	< -85.0		± 0.60
	2G to 6G	< -90.0		± 0.76
	6G to 10G	< -85.0		± 0.66
	10G to 18G	< -75.0		± 0.54
	18G to 20G	< -65.0		± 0.43
Port 3 - 3C (3B)	50M to 500M	< -65.0		± 0.35
	500M to 1G	< -80.0		± 0.48
	1G to 2G	< -85.0		± 0.60
	2G to 6G	< -90.0		± 0.76
	6G to 10G	< -85.0		± 0.66
	10G to 18G	< -75.0		± 0.54
	18G to 20G	< -65.0		± 0.43
Port 3 - 3C (3D)	50M to 500M	< -65.0		± 0.35
	500M to 1G	< -80.0		± 0.48
	1G to 2G	< -85.0		± 0.60
	2G to 6G	< -90.0		± 0.76
	6G to 10G	< -85.0		± 0.66
	10G to 18G	< -75.0		± 0.54
	18G to 20G	< -65.0		± 0.43
Port 3 - 3D (3A)	50M to 500M	< -65.0		± 0.35
	500M to 1G	< -80.0		± 0.48
	1G to 2G	< -85.0		± 0.60
	2G to 6G	< -90.0		± 0.76
	6G to 10G	< -85.0		± 0.66
	10G to 18G	< -75.0		± 0.54
	18G to 20G	< -65.0		± 0.43

Port - To Port (Selected Port)	Frequency Range [Hz]	Test Limit [dB]	Test Result [dB]	Measurement Uncertainty [dB]
Port 3 - 3D (3B)	50M to 500M	< -65.0		± 0.35
	500M to 1G	< -80.0		± 0.48
	1G to 2G	< -85.0		± 0.60
	2G to 6G	< -90.0		± 0.76
	6G to 10G	< -85.0		± 0.66
	10G to 18G	< -75.0		± 0.54
	18G to 20G	< -65.0		± 0.43
Port 3 - 3D (3C)	50M to 500M	< -65.0		± 0.35
	500M to 1G	< -80.0		± 0.48
	1G to 2G	< -85.0		± 0.60
	2G to 6G	< -90.0		± 0.76
	6G to 10G	< -85.0		± 0.66
	10G to 18G	< -75.0		± 0.54
	18G to 20G	< -65.0		± 0.43

From Selected Port To Unselected Port

From Port - To Port (Selected Port)	Frequency Range [Hz]	Test Limit [dB]	Test Result [dB]	Measurement Uncertainty [dB]
3A - 3B (3A)	50M to 500M	< -65.0		± 0.35
	500M to 1G	< -80.0		± 0.49
	1G to 2G	< -85.0		± 0.62
	2G to 6G	< -90.0		± 0.71
	6G to 10G	< -85.0		± 0.71
	10G to 18G	< -75.0		± 0.44
	18G to 20G	< -65.0		± 0.36

Performance Tests
E5092A Performance Test Record

From Port - To Port (Selected Port)	Frequency Range [Hz]	Test Limit [dB]	Test Result [dB]	Measurement Uncertainty [dB]
3A - 3C (3A)	50M to 500M	< -65.0		± 0.35
	500M to 1G	< -80.0		± 0.49
	1G to 2G	< -85.0		± 0.62
	2G to 6G	< -90.0		± 0.71
	6G to 10G	< -85.0		± 0.71
	10G to 18G	< -75.0		± 0.44
	18G to 20G	< -65.0		± 0.36
3A - 3D (3A)	50M to 500M	< -65.0		± 0.35
	500M to 1G	< -80.0		± 0.49
	1G to 2G	< -85.0		± 0.62
	2G to 6G	< -90.0		± 0.71
	6G to 10G	< -85.0		± 0.71
	10G to 18G	< -75.0		± 0.44
	18G to 20G	< -65.0		± 0.36
3B - 3C (3B)	50M to 500M	< -65.0		± 0.35
	500M to 1G	< -80.0		± 0.49
	1G to 2G	< -85.0		± 0.62
	2G to 6G	< -90.0		± 0.71
	6G to 10G	< -85.0		± 0.71
	10G to 18G	< -75.0		± 0.44
	18G to 20G	< -65.0		± 0.36
3B- 3D (3B)	50M to 500M	< -65.0		± 0.35
	500M to 1G	< -80.0		± 0.49
	1G to 2G	< -85.0		± 0.62
	2G to 6G	< -90.0		± 0.71
	6G to 10G	< -85.0		± 0.71
	10G to 18G	< -75.0		± 0.44
	18G to 20G	< -65.0		± 0.36

From Port - To Port (Selected Port)	Frequency Range [Hz]	Test Limit [dB]	Test Result [dB]	Measurement Uncertainty [dB]
3B - 3A (3B)	50M to 500M	< -65.0		± 0.35
	500M to 1G	< -80.0		± 0.49
	1G to 2G	< -85.0		± 0.62
	2G to 6G	< -90.0		± 0.71
	6G to 10G	< -85.0		± 0.71
	10G to 18G	< -75.0		± 0.44
	18G to 20G	< -65.0		± 0.36
3C - 3D (3C)	50M to 500M	< -65.0		± 0.35
	500M to 1G	< -80.0		± 0.49
	1G to 2G	< -85.0		± 0.62
	2G to 6G	< -90.0		± 0.71
	6G to 10G	< -85.0		± 0.71
	10G to 18G	< -75.0		± 0.44
	18G to 20G	< -65.0		± 0.36
3C - 3A (3C)	50M to 500M	< -65.0		± 0.35
	500M to 1G	< -80.0		± 0.49
	1G to 2G	< -85.0		± 0.62
	2G to 6G	< -90.0		± 0.71
	6G to 10G	< -85.0		± 0.71
	10G to 18G	< -75.0		± 0.44
	18G to 20G	< -65.0		± 0.36
3C - 3B (3C)	50M to 500M	< -65.0		± 0.35
	500M to 1G	< -80.0		± 0.49
	1G to 2G	< -85.0		± 0.62
	2G to 6G	< -90.0		± 0.71
	6G to 10G	< -85.0		± 0.71
	10G to 18G	< -75.0		± 0.44
	18G to 20G	< -65.0		± 0.36

Performance Tests
E5092A Performance Test Record

From Port - To Port (Selected Port)	Frequency Range [Hz]	Test Limit [dB]	Test Result [dB]	Measurement Uncertainty [dB]
3D - 3A (3D)	50M to 500M	< -65.0		± 0.35
	500M to 1G	< -80.0		± 0.49
	1G to 2G	< -85.0		± 0.62
	2G to 6G	< -90.0		± 0.71
	6G to 10G	< -85.0		± 0.71
	10G to 18G	< -75.0		± 0.44
	18G to 20G	< -65.0		± 0.36
3D - 3B (3D)	50M to 500M	< -65.0		± 0.35
	500M to 1G	< -80.0		± 0.49
	1G to 2G	< -85.0		± 0.62
	2G to 6G	< -90.0		± 0.71
	6G to 10G	< -85.0		± 0.71
	10G to 18G	< -75.0		± 0.44
	18G to 20G	< -65.0		± 0.36
3D - 3C (3D)	50M to 500M	< -65.0		± 0.35
	500M to 1G	< -80.0		± 0.49
	1G to 2G	< -85.0		± 0.62
	2G to 6G	< -90.0		± 0.71
	6G to 10G	< -85.0		± 0.71
	10G to 18G	< -75.0		± 0.44
	18G to 20G	< -65.0		± 0.36

From Unselected Port To Unselected Port

From Port - To Port (Selected Port)	Frequency Range [Hz]	Test Limit [dB]	Test Result [dB]	Measurement Uncertainty [dB]
3B - 3C (3A)	50M to 500M	< -65.0		± 0.35
	500M to 1G	< -80.0		± 0.49
	1G to 2G	< -85.0		± 0.62
	2G to 6G	< -90.0		± 0.71
	6G to 10G	< -85.0		± 0.71
	10G to 18G	< -75.0		± 0.44
	18G to 20G	< -65.0		± 0.36
3B - 3D (3A)	50M to 500M	< -65.0		± 0.35
	500M to 1G	< -80.0		± 0.49
	1G to 2G	< -85.0		± 0.62
	2G to 6G	< -90.0		± 0.71
	6G to 10G	< -85.0		± 0.71
	10G to 18G	< -75.0		± 0.44
	18G to 20G	< -65.0		± 0.36
3C - 3D (3A)	50M to 500M	< -65.0		± 0.35
	500M to 1G	< -80.0		± 0.49
	1G to 2G	< -85.0		± 0.62
	2G to 6G	< -90.0		± 0.71
	6G to 10G	< -85.0		± 0.71
	10G to 18G	< -75.0		± 0.44
	18G to 20G	< -65.0		± 0.36
3C - 3D (3B)	50M to 500M	< -65.0		± 0.35
	500M to 1G	< -80.0		± 0.49
	1G to 2G	< -85.0		± 0.62
	2G to 6G	< -90.0		± 0.71
	6G to 10G	< -85.0		± 0.71
	10G to 18G	< -75.0		± 0.44
	18G to 20G	< -65.0		± 0.36

Performance Tests
E5092A Performance Test Record

From Port - To Port (Selected Port)	Frequency Range [Hz]	Test Limit [dB]	Test Result [dB]	Measurement Uncertainty [dB]
3C - 3A (3B)	50M to 500M	< -65.0		± 0.35
	500M to 1G	< -80.0		± 0.49
	1G to 2G	< -85.0		± 0.62
	2G to 6G	< -90.0		± 0.71
	6G to 10G	< -85.0		± 0.71
	10G to 18G	< -75.0		± 0.44
	18G to 20G	< -65.0		± 0.36
3D - 3A (3B)	50M to 500M	< -65.0		± 0.35
	500M to 1G	< -80.0		± 0.49
	1G to 2G	< -85.0		± 0.62
	2G to 6G	< -90.0		± 0.71
	6G to 10G	< -85.0		± 0.71
	10G to 18G	< -75.0		± 0.44
	18G to 20G	< -65.0		± 0.36
3D - 3A (3C)	50M to 500M	< -65.0		± 0.35
	500M to 1G	< -80.0		± 0.49
	1G to 2G	< -85.0		± 0.62
	2G to 6G	< -90.0		± 0.71
	6G to 10G	< -85.0		± 0.71
	10G to 18G	< -75.0		± 0.44
	18G to 20G	< -65.0		± 0.36
3D - 3B (3C)	50M to 500M	< -65.0		± 0.35
	500M to 1G	< -80.0		± 0.49
	1G to 2G	< -85.0		± 0.62
	2G to 6G	< -90.0		± 0.71
	6G to 10G	< -85.0		± 0.71
	10G to 18G	< -75.0		± 0.44
	18G to 20G	< -65.0		± 0.36

From Port - To Port (Selected Port)	Frequency Range [Hz]	Test Limit [dB]	Test Result [dB]	Measurement Uncertainty [dB]
3A - 3B (3C)	50M to 500M	< -65.0		± 0.35
	500M to 1G	< -80.0		± 0.49
	1G to 2G	< -85.0		± 0.62
	2G to 6G	< -90.0		± 0.71
	6G to 10G	< -85.0		± 0.71
	10G to 18G	< -75.0		± 0.44
	18G to 20G	< -65.0		± 0.36
3A - 3B (3D)	50M to 500M	< -65.0		± 0.35
	500M to 1G	< -80.0		± 0.49
	1G to 2G	< -85.0		± 0.62
	2G to 6G	< -90.0		± 0.71
	6G to 10G	< -85.0		± 0.71
	10G to 18G	< -75.0		± 0.44
	18G to 20G	< -65.0		± 0.36
3A - 3C (3D)	50M to 500M	< -65.0		± 0.35
	500M to 1G	< -80.0		± 0.49
	1G to 2G	< -85.0		± 0.62
	2G to 6G	< -90.0		± 0.71
	6G to 10G	< -85.0		± 0.71
	10G to 18G	< -75.0		± 0.44
	18G to 20G	< -65.0		± 0.36
3B - 3C (3D)	50M to 500M	< -65.0		± 0.35
	500M to 1G	< -80.0		± 0.49
	1G to 2G	< -85.0		± 0.62
	2G to 6G	< -90.0		± 0.71
	6G to 10G	< -85.0		± 0.71
	10G to 18G	< -75.0		± 0.44
	18G to 20G	< -65.0		± 0.36

Performance Tests
E5092A Performance Test Record

Load Match, Insertion Loss and Isolation Test for Switch 4(SP4T, Port 4, 4A, 4B, 4C and 4D)

Load Match (Unselected)

Port (Selected Port)	Frequency Range [Hz]	Test Limit [dB]	Test Result [dB]	Measurement Uncertainty [dB]
4B (4A)	50M to 3G	< -17.0		± 0.43
	3G to 10G	< -11.0		± 0.37
	10G to 16G	< -8.0		± 0.28
	16G to 18G	< -6.0		± 0.28
	18G to 20G	< -4.0		± 0.35
4C (4A)	50M to 3G	< -17.0		± 0.43
	3G to 10G	< -11.0		± 0.37
	10G to 16G	< -8.0		± 0.28
	16G to 18G	< -6.0		± 0.28
	18G to 20G	< -4.0		± 0.35
4D (4A)	50M to 3G	< -17.0		± 0.43
	3G to 10G	< -11.0		± 0.37
	10G to 16G	< -8.0		± 0.28
	16G to 18G	< -6.0		± 0.28
	18G to 20G	< -4.0		± 0.35
4A (4B)	50M to 3G	< -17.0		± 0.43
	3G to 10G	< -11.0		± 0.37
	10G to 16G	< -8.0		± 0.28
	16G to 18G	< -6.0		± 0.28
	18G to 20G	< -4.0		± 0.35
4C (4B)	50M to 3G	< -17.0		± 0.43
	3G to 10G	< -11.0		± 0.37
	10G to 16G	< -8.0		± 0.28
	16G to 18G	< -6.0		± 0.28
	18G to 20G	< -4.0		± 0.35

Port (Selected Port)	Frequency Range [Hz]	Test Limit [dB]	Test Result [dB]	Measurement Uncertainty [dB]
4D (4B)	50M to 3G	< -17.0		± 0.43
	3G to 10G	< -11.0		± 0.37
	10G to 16G	< -8.0		± 0.28
	16G to 18G	< -6.0		± 0.28
	18G to 20G	< -4.0		± 0.35
4A (4C)	50M to 3G	< -17.0		± 0.43
	3G to 10G	< -11.0		± 0.37
	10G to 16G	< -8.0		± 0.28
	16G to 18G	< -6.0		± 0.28
	18G to 20G	< -4.0		± 0.35
4B (4C)	50M to 3G	< -17.0		± 0.43
	3G to 10G	< -11.0		± 0.37
	10G to 16G	< -8.0		± 0.28
	16G to 18G	< -6.0		± 0.28
	18G to 20G	< -4.0		± 0.35
4D (4C)	50M to 3G	< -17.0		± 0.43
	3G to 10G	< -11.0		± 0.37
	10G to 16G	< -8.0		± 0.28
	16G to 18G	< -6.0		± 0.28
	18G to 20G	< -4.0		± 0.35
4A (4D)	50M to 3G	< -17.0		± 0.43
	3G to 10G	< -11.0		± 0.37
	10G to 16G	< -8.0		± 0.28
	16G to 18G	< -6.0		± 0.28
	18G to 20G	< -4.0		± 0.35

Performance Tests
E5092A Performance Test Record

Port (Selected Port)	Frequency Range [Hz]	Test Limit [dB]	Test Result [dB]	Measurement Uncertainty [dB]
4B (4D)	50M to 3G	< -17.0		± 0.43
	3G to 10G	< -11.0		± 0.37
	10G to 16G	< -8.0		± 0.28
	16G to 18G	< -6.0		± 0.28
	18G to 20G	< -4.0		± 0.35
4C (4D)	50M to 3G	< -17.0		± 0.43
	3G to 10G	< -11.0		± 0.37
	10G to 16G	< -8.0		± 0.28
	16G to 18G	< -6.0		± 0.28
	18G to 20G	< -4.0		± 0.35

Load Match (Selected)

Port (Selected Port)	Frequency Range [Hz]	Test Limit [dB]	Test Result [dB]	Measurement Uncertainty [dB]
4A (4A)	50M to 2G	< -17.0		± 0.37
	2G to 3G	< -11.0		± 0.28
	3G to 8G	< -8.0		± 0.18
	8G to 10G	< -7.0		± 0.28
	10G to 18G	< -4.0		± 0.29
	18G to 20G	< -4.0		± 0.29
4B (4B)	50M to 2G	< -17.0		± 0.37
	2G to 3G	< -11.0		± 0.28
	3G to 8G	< -8.0		± 0.18
	8G to 10G	< -7.0		± 0.28
	10G to 18G	< -4.0		± 0.29
	18G to 20G	< -4.0		± 0.29

Port (Selected Port)	Frequency Range [Hz]	Test Limit [dB]	Test Result [dB]	Measurement Uncertainty [dB]
4C (4C)	50M to 2G	< -17.0		± 0.37
	2G to 3G	< -11.0		± 0.28
	3G to 8G	< -8.0		± 0.18
	8G to 10G	< -7.0		± 0.28
	10G to 18G	< -4.0		± 0.29
	18G to 20G	< -4.0		± 0.29
4D (4D)	50M to 2G	< -17.0		± 0.37
	2G to 3G	< -11.0		± 0.28
	3G to 8G	< -8.0		± 0.18
	8G to 10G	< -7.0		± 0.28
	10G to 18G	< -4.0		± 0.29
	18G to 20G	< -4.0		± 0.29

Load Match (COM)

Port (Selected Port)	Frequency Range [Hz]	Test Limit [dB]	Test Result [dB]	Measurement Uncertainty [dB]
Port 4 (4A)	50M to 1.3G	< -16.0		± 0.30
	1.3G to 4G	< -11.0		± 0.23
	4G to 8G	< -8.0		± 0.12
	8G to 10G	< -7.0		± 0.13
	10G to 20G	< -4.0		± 0.10
Port 4 (4B)	50M to 1.3G	< -16.0		± 0.30
	1.3G to 4G	< -11.0		± 0.23
	4G to 8G	< -8.0		± 0.12
	8G to 10G	< -7.0		± 0.13
	10G to 20G	< -4.0		± 0.10

Performance Tests
E5092A Performance Test Record

Port (Selected Port)	Frequency Range [Hz]	Test Limit [dB]	Test Result [dB]	Measurement Uncertainty [dB]
Port 4 (4C)	50M to 1.3G	< -16.0		± 0.30
	1.3G to 4G	< -11.0		± 0.23
	4G to 8G	< -8.0		± 0.12
	8G to 10G	< -7.0		± 0.13
	10G to 20G	< -4.0		± 0.10
Port 4 (4D)	50M to 1.3G	< -16.0		± 0.30
	1.3G to 4G	< -11.0		± 0.23
	4G to 8G	< -8.0		± 0.12
	8G to 10G	< -7.0		± 0.13
	10G to 20G	< -4.0		± 0.10

Insertion Loss

From Port - To Port	Frequency Range [Hz]	Test Limit [dB]	Test Result [dB]	Measurement Uncertainty [dB]
Port 4- 4A	50M to 100M	> -4.0		± 0.27
	100M to 2G	> -3.5		± 0.24
	2G to 3G	> -4.5		± 0.18
	3G to 4G	> -5.5		± 0.19
	4G to 6G	> -6.0		± 0.11
	6G to 8G	> -7.5		± 0.09
	8G to 10G	> -8.5		± 0.24
	10G to 14G	> -9.5		± 0.29
	14G to 18G	> -10.5		± 0.29
	18G to 20G	> -12.0		± 0.63

From Port - To Port	Frequency Range [Hz]	Test Limit [dB]	Test Result [dB]	Measurement Uncertainty [dB]
Port 4 - 4B	50M to 100M	> -4.0		± 0.27
	100M to 2G	> -3.5		± 0.24
	2G to 3G	> -4.5		± 0.18
	3G to 4G	> -5.5		± 0.19
	4G to 6G	> -6.0		± 0.11
	6G to 8G	> -7.5		± 0.09
	8G to 10G	> -8.5		± 0.24
	10G to 14G	> -9.5		± 0.29
	14G to 18G	> -10.5		± 0.29
	18G to 20G	> -12.0		± 0.63
Port 4 - 4C	50M to 100M	> -4.0		± 0.27
	100M to 2G	> -3.5		± 0.24
	2G to 3G	> -4.5		± 0.18
	3G to 4G	> -5.5		± 0.19
	4G to 6G	> -6.0		± 0.11
	6G to 8G	> -7.5		± 0.09
	8G to 10G	> -8.5		± 0.24
	10G to 14G	> -9.5		± 0.29
	14G to 18G	> -10.5		± 0.29
	18G to 20G	> -12.0		± 0.63

Performance Tests
E5092A Performance Test Record

From Port - To Port	Frequency Range [Hz]	Test Limit [dB]	Test Result [dB]	Measurement Uncertainty [dB]
Port 4 - 4D	50M to 100M	> -4.0		± 0.27
	100M to 2G	> -3.5		± 0.24
	2G to 3G	> -4.5		± 0.18
	3G to 4G	> -5.5		± 0.19
	4G to 6G	> -6.0		± 0.11
	6G to 8G	> -7.5		± 0.09
	8G to 10G	> -8.5		± 0.24
	10G to 14G	> -9.5		± 0.29
	14G to 18G	> -10.5		± 0.29
	18G to 20G	> -12.0		± 0.63

Isolation

From Common Port To Unselected Port

Port - To Port (Selected Port)	Frequency Range [Hz]	Test Limit [dB]	Test Result [dB]	Measurement Uncertainty [dB]
Port 4 - 4A (4B)	50M to 500M	< -65.0		± 0.35
	500M to 1G	< -80.0		± 0.48
	1G to 2G	< -85.0		± 0.60
	2G to 6G	< -90.0		± 0.76
	6G to 10G	< -85.0		± 0.66
	10G to 18G	< -75.0		± 0.54
	18G to 20G	< -65.0		± 0.43
Port 4 - 4A (4C)	50M to 500M	< -65.0		± 0.35
	500M to 1G	< -80.0		± 0.48
	1G to 2G	< -85.0		± 0.60
	2G to 6G	< -90.0		± 0.76
	6G to 10G	< -85.0		± 0.66
	10G to 18G	< -75.0		± 0.54
	18G to 20G	< -65.0		± 0.43

Port - To Port (Selected Port)	Frequency Range [Hz]	Test Limit [dB]	Test Result [dB]	Measurement Uncertainty [dB]
Port 4 - 4A (4D)	50M to 500M	< -65.0		± 0.35
	500M to 1G	< -80.0		± 0.48
	1G to 2G	< -85.0		± 0.60
	2G to 6G	< -90.0		± 0.76
	6G to 10G	< -85.0		± 0.66
	10G to 18G	< -75.0		± 0.54
	18G to 20G	< -65.0		± 0.43
Port 4 - 4B (4A)	50M to 500M	< -65.0		± 0.35
	500M to 1G	< -80.0		± 0.48
	1G to 2G	< -85.0		± 0.60
	2G to 6G	< -90.0		± 0.76
	6G to 10G	< -85.0		± 0.66
	10G to 18G	< -75.0		± 0.54
	18G to 20G	< -65.0		± 0.43
Port 4 - 4B (4C)	50M to 500M	< -65.0		± 0.35
	500M to 1G	< -80.0		± 0.48
	1G to 2G	< -85.0		± 0.60
	2G to 6G	< -90.0		± 0.76
	6G to 10G	< -85.0		± 0.66
	10G to 18G	< -75.0		± 0.54
	18G to 20G	< -65.0		± 0.43
Port 4 - 4B (4D)	50M to 500M	< -65.0		± 0.35
	500M to 1G	< -80.0		± 0.48
	1G to 2G	< -85.0		± 0.60
	2G to 6G	< -90.0		± 0.76
	6G to 10G	< -85.0		± 0.66
	10G to 18G	< -75.0		± 0.54
	18G to 20G	< -65.0		± 0.43

Performance Tests
E5092A Performance Test Record

Port - To Port (Selected Port)	Frequency Range [Hz]	Test Limit [dB]	Test Result [dB]	Measurement Uncertainty [dB]
Port 4 - 4C (4A)	50M to 500M	< -65.0		± 0.35
	500M to 1G	< -80.0		± 0.48
	1G to 2G	< -85.0		± 0.60
	2G to 6G	< -90.0		± 0.76
	6G to 10G	< -85.0		± 0.66
	10G to 18G	< -75.0		± 0.54
	18G to 20G	< -65.0		± 0.43
Port 4 - 4C (4B)	50M to 500M	< -65.0		± 0.35
	500M to 1G	< -80.0		± 0.48
	1G to 2G	< -85.0		± 0.60
	2G to 6G	< -90.0		± 0.76
	6G to 10G	< -85.0		± 0.66
	10G to 18G	< -75.0		± 0.54
	18G to 20G	< -65.0		± 0.43
Port 4 - 4C (4D)	50M to 500M	< -65.0		± 0.35
	500M to 1G	< -80.0		± 0.48
	1G to 2G	< -85.0		± 0.60
	2G to 6G	< -90.0		± 0.76
	6G to 10G	< -85.0		± 0.66
	10G to 18G	< -75.0		± 0.54
	18G to 20G	< -65.0		± 0.43
Port 4 - 4D (4A)	50M to 500M	< -65.0		± 0.35
	500M to 1G	< -80.0		± 0.48
	1G to 2G	< -85.0		± 0.60
	2G to 6G	< -90.0		± 0.76
	6G to 10G	< -85.0		± 0.66
	10G to 18G	< -75.0		± 0.54
	18G to 20G	< -65.0		± 0.43

Port - To Port (Selected Port)	Frequency Range [Hz]	Test Limit [dB]	Test Result [dB]	Measurement Uncertainty [dB]
Port 4 - 4D (4B)	50M to 500M	< -65.0		± 0.35
	500M to 1G	< -80.0		± 0.48
	1G to 2G	< -85.0		± 0.60
	2G to 6G	< -90.0		± 0.76
	6G to 10G	< -85.0		± 0.66
	10G to 18G	< -75.0		± 0.54
	18G to 20G	< -65.0		± 0.43
Port 4 - 4D (4C)	50M to 500M	< -65.0		± 0.35
	500M to 1G	< -80.0		± 0.48
	1G to 2G	< -85.0		± 0.60
	2G to 6G	< -90.0		± 0.76
	6G to 10G	< -85.0		± 0.66
	10G to 18G	< -75.0		± 0.54
	18G to 20G	< -65.0		± 0.43

From Selected Port To Unselected Port

From Port - To Port (Selected Port)	Frequency Range [Hz]	Test Limit [dB]	Test Result [dB]	Measurement Uncertainty [dB]
4A - 4B (4A)	50M to 500M	< -65.0		± 0.35
	500M to 1G	< -80.0		± 0.49
	1G to 2G	< -85.0		± 0.62
	2G to 6G	< -90.0		± 0.71
	6G to 10G	< -85.0		± 0.71
	10G to 18G	< -75.0		± 0.44
	18G to 20G	< -65.0		± 0.36

Performance Tests
E5092A Performance Test Record

From Port - To Port (Selected Port)	Frequency Range [Hz]	Test Limit [dB]	Test Result [dB]	Measurement Uncertainty [dB]
4A - 4C (4A)	50M to 500M	< -65.0		± 0.35
	500M to 1G	< -80.0		± 0.49
	1G to 2G	< -85.0		± 0.62
	2G to 6G	< -90.0		± 0.71
	6G to 10G	< -85.0		± 0.71
	10G to 18G	< -75.0		± 0.44
	18G to 20G	< -65.0		± 0.36
4A - 4D (4A)	50M to 500M	< -65.0		± 0.35
	500M to 1G	< -80.0		± 0.49
	1G to 2G	< -85.0		± 0.62
	2G to 6G	< -90.0		± 0.71
	6G to 10G	< -85.0		± 0.71
	10G to 18G	< -75.0		± 0.44
	18G to 20G	< -65.0		± 0.36
4B - 4C (4B)	50M to 500M	< -65.0		± 0.35
	500M to 1G	< -80.0		± 0.49
	1G to 2G	< -85.0		± 0.62
	2G to 6G	< -90.0		± 0.71
	6G to 10G	< -85.0		± 0.71
	10G to 18G	< -75.0		± 0.44
	18G to 20G	< -65.0		± 0.36
4B- 4D (4B)	50M to 500M	< -65.0		± 0.35
	500M to 1G	< -80.0		± 0.49
	1G to 2G	< -85.0		± 0.62
	2G to 6G	< -90.0		± 0.71
	6G to 10G	< -85.0		± 0.71
	10G to 18G	< -75.0		± 0.44
	18G to 20G	< -65.0		± 0.36

From Port - To Port (Selected Port)	Frequency Range [Hz]	Test Limit [dB]	Test Result [dB]	Measurement Uncertainty [dB]
4B - 4A (4B)	50M to 500M	< -65.0		± 0.35
	500M to 1G	< -80.0		± 0.49
	1G to 2G	< -85.0		± 0.62
	2G to 6G	< -90.0		± 0.71
	6G to 10G	< -85.0		± 0.71
	10G to 18G	< -75.0		± 0.44
	18G to 20G	< -65.0		± 0.36
4C - 4D (4C)	50M to 500M	< -65.0		± 0.35
	500M to 1G	< -80.0		± 0.49
	1G to 2G	< -85.0		± 0.62
	2G to 6G	< -90.0		± 0.71
	6G to 10G	< -85.0		± 0.71
	10G to 18G	< -75.0		± 0.44
	18G to 20G	< -65.0		± 0.36
4C - 4A (4C)	50M to 500M	< -65.0		± 0.35
	500M to 1G	< -80.0		± 0.49
	1G to 2G	< -85.0		± 0.62
	2G to 6G	< -90.0		± 0.71
	6G to 10G	< -85.0		± 0.71
	10G to 18G	< -75.0		± 0.44
	18G to 20G	< -65.0		± 0.36
4C - 4B (4C)	50M to 500M	< -65.0		± 0.35
	500M to 1G	< -80.0		± 0.49
	1G to 2G	< -85.0		± 0.62
	2G to 6G	< -90.0		± 0.71
	6G to 10G	< -85.0		± 0.71
	10G to 18G	< -75.0		± 0.44
	18G to 20G	< -65.0		± 0.36

Performance Tests
E5092A Performance Test Record

From Port - To Port (Selected Port)	Frequency Range [Hz]	Test Limit [dB]	Test Result [dB]	Measurement Uncertainty [dB]
4D - 4A (4D)	50M to 500M	< -65.0		± 0.35
	500M to 1G	< -80.0		± 0.49
	1G to 2G	< -85.0		± 0.62
	2G to 6G	< -90.0		± 0.71
	6G to 10G	< -85.0		± 0.71
	10G to 18G	< -75.0		± 0.44
	18G to 20G	< -65.0		± 0.36
4D - 4B (4D)	50M to 500M	< -65.0		± 0.35
	500M to 1G	< -80.0		± 0.49
	1G to 2G	< -85.0		± 0.62
	2G to 6G	< -90.0		± 0.71
	6G to 10G	< -85.0		± 0.71
	10G to 18G	< -75.0		± 0.44
	18G to 20G	< -65.0		± 0.36
4D - 4C (4D)	50M to 500M	< -65.0		± 0.35
	500M to 1G	< -80.0		± 0.49
	1G to 2G	< -85.0		± 0.62
	2G to 6G	< -90.0		± 0.71
	6G to 10G	< -85.0		± 0.71
	10G to 18G	< -75.0		± 0.44
	18G to 20G	< -65.0		± 0.36

From Unselected Port To Unselected Port

From Port - To Port (Selected Port)	Frequency Range [Hz]	Test Limit [dB]	Test Result [dB]	Measurement Uncertainty [dB]
4B - 4C (4A)	50M to 500M	< -65.0		± 0.35
	500M to 1G	< -80.0		± 0.49
	1G to 2G	< -85.0		± 0.62
	2G to 6G	< -90.0		± 0.71
	6G to 10G	< -85.0		± 0.71
	10G to 18G	< -75.0		± 0.44
	18G to 20G	< -65.0		± 0.36
4B - 4D (4A)	50M to 500M	< -65.0		± 0.35
	500M to 1G	< -80.0		± 0.49
	1G to 2G	< -85.0		± 0.62
	2G to 6G	< -90.0		± 0.71
	6G to 10G	< -85.0		± 0.71
	10G to 18G	< -75.0		± 0.44
	18G to 20G	< -65.0		± 0.36
4C - 4D (4A)	50M to 500M	< -65.0		± 0.35
	500M to 1G	< -80.0		± 0.49
	1G to 2G	< -85.0		± 0.62
	2G to 6G	< -90.0		± 0.71
	6G to 10G	< -85.0		± 0.71
	10G to 18G	< -75.0		± 0.44
	18G to 20G	< -65.0		± 0.36
4C - 4D (4B)	50M to 500M	< -65.0		± 0.35
	500M to 1G	< -80.0		± 0.49
	1G to 2G	< -85.0		± 0.62
	2G to 6G	< -90.0		± 0.71
	6G to 10G	< -85.0		± 0.71
	10G to 18G	< -75.0		± 0.44
	18G to 20G	< -65.0		± 0.36

Performance Tests
E5092A Performance Test Record

From Port - To Port (Selected Port)	Frequency Range [Hz]	Test Limit [dB]	Test Result [dB]	Measurement Uncertainty [dB]
4C - 4A (4B)	50M to 500M	< -65.0		± 0.35
	500M to 1G	< -80.0		± 0.49
	1G to 2G	< -85.0		± 0.62
	2G to 6G	< -90.0		± 0.71
	6G to 10G	< -85.0		± 0.71
	10G to 18G	< -75.0		± 0.44
	18G to 20G	< -65.0		± 0.36
4D - 4A (4B)	50M to 500M	< -65.0		± 0.35
	500M to 1G	< -80.0		± 0.49
	1G to 2G	< -85.0		± 0.62
	2G to 6G	< -90.0		± 0.71
	6G to 10G	< -85.0		± 0.71
	10G to 18G	< -75.0		± 0.44
	18G to 20G	< -65.0		± 0.36
4D - 4A (4C)	50M to 500M	< -65.0		± 0.35
	500M to 1G	< -80.0		± 0.49
	1G to 2G	< -85.0		± 0.62
	2G to 6G	< -90.0		± 0.71
	6G to 10G	< -85.0		± 0.71
	10G to 18G	< -75.0		± 0.44
	18G to 20G	< -65.0		± 0.36
4D - 4B (4C)	50M to 500M	< -65.0		± 0.35
	500M to 1G	< -80.0		± 0.49
	1G to 2G	< -85.0		± 0.62
	2G to 6G	< -90.0		± 0.71
	6G to 10G	< -85.0		± 0.71
	10G to 18G	< -75.0		± 0.44
	18G to 20G	< -65.0		± 0.36

From Port - To Port (Selected Port)	Frequency Range [Hz]	Test Limit [dB]	Test Result [dB]	Measurement Uncertainty [dB]
4A - 4B (4C)	50M to 500M	< -65.0		± 0.35
	500M to 1G	< -80.0		± 0.49
	1G to 2G	< -85.0		± 0.62
	2G to 6G	< -90.0		± 0.71
	6G to 10G	< -85.0		± 0.71
	10G to 18G	< -75.0		± 0.44
	18G to 20G	< -65.0		± 0.36
4A - 4B (4D)	50M to 500M	< -65.0		± 0.35
	500M to 1G	< -80.0		± 0.49
	1G to 2G	< -85.0		± 0.62
	2G to 6G	< -90.0		± 0.71
	6G to 10G	< -85.0		± 0.71
	10G to 18G	< -75.0		± 0.44
	18G to 20G	< -65.0		± 0.36
4A - 4C (4D)	50M to 500M	< -65.0		± 0.35
	500M to 1G	< -80.0		± 0.49
	1G to 2G	< -85.0		± 0.62
	2G to 6G	< -90.0		± 0.71
	6G to 10G	< -85.0		± 0.71
	10G to 18G	< -75.0		± 0.44
	18G to 20G	< -65.0		± 0.36
4B - 4C (4D)	50M to 500M	< -65.0		± 0.35
	500M to 1G	< -80.0		± 0.49
	1G to 2G	< -85.0		± 0.62
	2G to 6G	< -90.0		± 0.71
	6G to 10G	< -85.0		± 0.71
	10G to 18G	< -75.0		± 0.44
	18G to 20G	< -65.0		± 0.36

Load Match, Insertion Loss and Isolation Test for Switch 5(SPDT, 5COM, 5A and 5B)

Load Match (Unselected)

Port (Selected Port)	Frequency Range [Hz]	Test Limit [dB]	Test Result [dB]	Measurement Uncertainty [dB]
5A (5B)	50M to 3G	< -17.0		± 0.43
	3G to 10G	< -11.0		± 0.37
	10G to 16G	< -8.0		± 0.28
	16G to 18G	< -6.0		± 0.28
	18G to 20G	< -4.0		± 0.35

Load Match (Selected)

Port (Selected Port)	Frequency Range [Hz]	Test Limit [dB]	Test Result [dB]	Measurement Uncertainty [dB]
5A (5A)	50M to 2G	< -17.0		± 0.37
	2G to 4G	< -11.0		± 0.27
	4G to 8G	< -8.0		± 0.18
	8G to 10G	< -7.0		± 0.28
	10G to 18G	< -4.0		± 0.29
	18G to 20G	< -4.0		± 0.29
5B (5B)	50M to 2G	< -17.0		± 0.37
	2G to 4G	< -11.0		± 0.27
	4G to 8G	< -8.0		± 0.18
	8G to 10G	< -7.0		± 0.28
	10G to 18G	< -4.0		± 0.29
	18G to 20G	< -4.0		± 0.29

Load Match (COM)

Port (Selected Port)	Frequency Range [Hz]	Test Limit [dB]	Test Result [dB]	Measurement Uncertainty [dB]
5COM (5A)	50M to 2G	< -16.0		± 0.30
	2G to 4G	< -11.0		± 0.23
	4G to 8G	< -8.0		± 0.12
	8G to 10G	< -7.0		± 0.13
	10G to 20G	< -4.0		± 0.10
5COM (5B)	50M to 2G	< -16.0		± 0.30
	2G to 4G	< -11.0		± 0.23
	4G to 8G	< -8.0		± 0.12
	8G to 10G	< -7.0		± 0.13
	10G to 20G	< -4.0		± 0.10

Insertion Loss

From Port - To Port	Frequency Range [Hz]	Test Limit [dB]	Test Result [dB]	Measurement Uncertainty [dB]
5COM - 5A	50M to 100M	> -4.0		± 0.27
	100M to 2G	> -3.5		± 0.24
	2G to 3G	> -4.5		± 0.18
	3G to 4G	> -5.0		± 0.19
	4G to 6G	> -5.5		± 0.11
	6G to 8G	> -7.0		± 0.09
	8G to 10G	> -8.0		± 0.24
	10G to 14G	> -8.5		± 0.23
	14G to 18G	> -10.0		± 0.29
	18G to 20G	> -11.5		± 0.59

Performance Tests
E5092A Performance Test Record

From Port - To Port	Frequency Range [Hz]	Test Limit [dB]	Test Result [dB]	Measurement Uncertainty [dB]
5COM - 5B	50M to 100M	> -4.0		± 0.27
	100M to 2G	> -3.5		± 0.24
	2G to 3G	> -4.5		± 0.18
	3G to 4G	> -5.0		± 0.19
	4G to 6G	> -5.5		± 0.11
	6G to 8G	> -7.0		± 0.09
	8G to 10G	> -8.0		± 0.24
	10G to 14G	> -8.5		± 0.23
	14G to 18G	> -10.0		± 0.29
	18G to 20G	> -11.5		± 0.59

Isolation

From Common Port to Unselected Port

From Port - To Port (Selected Port)	Frequency Range [Hz]	Test Limit [dB]	Test Result [dB]	Measurement Uncertainty [dB]
5COM - 5A (5B)	50M to 500M	< -65.0		± 0.35
	500M to 1G	< -80.0		± 0.48
	1G to 2G	< -85.0		± 0.60
	2G to 6G	< -90.0		± 0.76
	6G to 10G	< -85.0		± 0.66
	10G to 18G	< -75.0		± 0.54
	18G to 20G	< -65.0		± 0.43
5COM - 5B (5A)	50M to 500M	< -65.0		± 0.35
	500M to 1G	< -80.0		± 0.48
	1G to 2G	< -85.0		± 0.60
	2G to 6G	< -90.0		± 0.76
	6G to 10G	< -85.0		± 0.66
	10G to 18G	< -75.0		± 0.54
	18G to 20G	< -65.0		± 0.43

From Selected Port To Unselected Port

From Port - To Port (Selected Port)	Frequency Range [Hz]	Test Limit [dB]	Test Result [dB]	Measurement Uncertainty [dB]
5A - 5B (5A)	50M to 500M	< -65.0		± 0.35
	500M to 1G	< -80.0		± 0.49
	1G to 2G	< -85.0		± 0.62
	2G to 6G	< -90.0		± 0.71
	6G to 10G	< -85.0		± 0.71
	10G to 18G	< -75.0		± 0.44
	18G to 20G	< -65.0		± 0.36
5B - 5A (5B)	50M to 500M	< -65.0		± 0.35
	500M to 1G	< -80.0		± 0.49
	1G to 2G	< -85.0		± 0.62
	2G to 6G	< -90.0		± 0.71
	6G to 10G	< -85.0		± 0.71
	10G to 18G	< -75.0		± 0.44
	18G to 20G	< -65.0		± 0.36

Load Match, Insertion Loss and Isolation Test for Switch 6(SPDT, 6COM, 6A and 6B)

Load Match (Unselected)

Port (Selected Port)	Frequency Range [Hz]	Test Limit [dB]	Test Result [dB]	Measurement Uncertainty [dB]
6A (6B)	50M to 3G	< -17.0		± 0.43
	3G to 10G	< -11.0		± 0.37
	10G to 16G	< -8.0		± 0.28
	16G to 18G	< -6.0		± 0.28
	18G to 20G	< -4.0		± 0.35

Load Match (Selected)

Port (Selected Port)	Frequency Range [Hz]	Test Limit [dB]	Test Result [dB]	Measurement Uncertainty [dB]
6A (6A)	50M to 2G	< -17.0		± 0.37
	2G to 4G	< -11.0		± 0.27
	4G to 8G	< -8.0		± 0.18
	8G to 10G	< -7.0		± 0.28
	10G to 18G	< -4.0		± 0.29
	18G to 20G	< -4.0		± 0.29
6B (6B)	50M to 2G	< -17.0		± 0.37
	2G to 4G	< -11.0		± 0.27
	4G to 8G	< -8.0		± 0.18
	8G to 10G	< -7.0		± 0.28
	10G to 18G	< -4.0		± 0.29
	18G to 20G	< -4.0		± 0.29

Load Match (COM)

Port (Selected Port)	Frequency Range [Hz]	Test Limit [dB]	Test Result [dB]	Measurement Uncertainty [dB]
6COM (6A)	50M to 2G	< -16.0		± 0.30
	2G to 4G	< -11.0		± 0.23
	4G to 8G	< -8.0		± 0.12
	8G to 10G	< -7.0		± 0.13
	10G to 20G	< -4.0		± 0.10
6COM (6B)	50M to 2G	< -16.0		± 0.30
	2G to 4G	< -11.0		± 0.23
	4G to 8G	< -8.0		± 0.12
	8G to 10G	< -7.0		± 0.13
	10G to 20G	< -4.0		± 0.10

Insertion Loss

From Port - To Port	Frequency Range [Hz]	Test Limit [dB]	Test Result [dB]	Measurement Uncertainty [dB]
6COM - 6A	50M to 100M	> -4.0		± 0.27
	100M to 2G	> -3.5		± 0.24
	2G to 3G	> -4.5		± 0.18
	3G to 4G	> -5.0		± 0.19
	4G to 6G	> -5.5		± 0.11
	6G to 8G	> -7.0		± 0.09
	8G to 10G	> -8.0		± 0.24
	10G to 14G	> -8.5		± 0.23
	14G to 18G	> -10.0		± 0.29
	18G to 20G	> -11.5		± 0.59

Performance Tests
E5092A Performance Test Record

From Port - To Port	Frequency Range [Hz]	Test Limit [dB]	Test Result [dB]	Measurement Uncertainty [dB]
6COM - 6B	50M to 100M	> -4.0		± 0.27
	100M to 2G	> -3.5		± 0.24
	2G to 3G	> -4.5		± 0.18
	3G to 4G	> -5.0		± 0.19
	4G to 6G	> -5.5		± 0.11
	6G to 8G	> -7.0		± 0.09
	8G to 10G	> -8.0		± 0.24
	10G to 14G	> -8.5		± 0.23
	14G to 18G	> -10.0		± 0.29
	18G to 20G	> -11.5		± 0.59

Isolation

From Common Port to Unselected Port

From Port - To Port (Selected Port)	Frequency Range [Hz]	Test Limit [dB]	Test Result [dB]	Measurement Uncertainty [dB]
6COM - 6A (6B)	50M to 500M	< -65.0		± 0.35
	500M to 1G	< -80.0		± 0.48
	1G to 2G	< -85.0		± 0.60
	2G to 6G	< -90.0		± 0.76
	6G to 10G	< -85.0		± 0.66
	10G to 18G	< -75.0		± 0.54
	18G to 20G	< -65.0		± 0.43
6COM - 6B (6A)	50M to 500M	< -65.0		± 0.35
	500M to 1G	< -80.0		± 0.48
	1G to 2G	< -85.0		± 0.60
	2G to 6G	< -90.0		± 0.76
	6G to 10G	< -85.0		± 0.66
	10G to 18G	< -75.0		± 0.54
	18G to 20G	< -65.0		± 0.43

From Selected Port To Unselected Port

From Port - To Port (Selected Port)	Frequency Range [Hz]	Test Limit [dB]	Test Result [dB]	Measurement Uncertainty [dB]
6A - 6B (6A)	50M to 500M	< -65.0		± 0.35
	500M to 1G	< -80.0		± 0.49
	1G to 2G	< -85.0		± 0.62
	2G to 6G	< -90.0		± 0.71
	6G to 10G	< -85.0		± 0.71
	10G to 18G	< -75.0		± 0.44
	18G to 20G	< -65.0		± 0.36
6B - 6A (6B)	50M to 500M	< -65.0		± 0.35
	500M to 1G	< -80.0		± 0.49
	1G to 2G	< -85.0		± 0.62
	2G to 6G	< -90.0		± 0.71
	6G to 10G	< -85.0		± 0.71
	10G to 18G	< -75.0		± 0.44
	18G to 20G	< -65.0		± 0.36

Load Match, Insertion Loss and Isolation Test for Switch 7 (SPDT, 7COM, 7A and 7B)

Load Match (Unselected)

Port (Selected Port)	Frequency Range [Hz]	Test Limit [dB]	Test Result [dB]	Measurement Uncertainty [dB]
7A (7B)	50M to 3G	< -17.0		± 0.43
	3G to 10G	< -11.0		± 0.37
	10G to 16G	< -8.0		± 0.28
	16G to 18G	< -6.0		± 0.28
	18G to 20G	< -4.0		± 0.35

Load Match (Selected)

Port (Selected Port)	Frequency Range [Hz]	Test Limit [dB]	Test Result [dB]	Measurement Uncertainty [dB]
7A (7A)	50M to 2G	< -17.0		± 0.37
	2G to 4G	< -11.0		± 0.27
	4G to 8G	< -8.0		± 0.18
	8G to 10G	< -7.0		± 0.28
	10G to 18G	< -4.0		± 0.29
	18G to 20G	< -4.0		± 0.29
7B (7B)	50M to 2G	< -17.0		± 0.37
	2G to 4G	< -11.0		± 0.27
	4G to 8G	< -8.0		± 0.18
	8G to 10G	< -7.0		± 0.28
	10G to 18G	< -4.0		± 0.29
	18G to 20G	< -4.0		± 0.29

Load Match (COM)

Port (Selected Port)	Frequency Range [Hz]	Test Limit [dB]	Test Result [dB]	Measurement Uncertainty [dB]
7COM (7A)	50M to 2G	< -16.0		± 0.30
	2G to 4G	< -11.0		± 0.23
	4G to 8G	< -8.0		± 0.12
	8G to 10G	< -7.0		± 0.13
	10G to 20G	< -4.0		± 0.10
7COM (7B)	50M to 2G	< -16.0		± 0.30
	2G to 4G	< -11.0		± 0.23
	4G to 8G	< -8.0		± 0.12
	8G to 10G	< -7.0		± 0.13
	10G to 20G	< -4.0		± 0.10

Insertion Loss

From Port - To Port	Frequency Range [Hz]	Test Limit [dB]	Test Result [dB]	Measurement Uncertainty [dB]
7COM - 7A	50M to 100M	> -4.0		± 0.27
	100M to 2G	> -3.5		± 0.24
	2G to 3G	> -4.5		± 0.18
	3G to 4G	> -5.0		± 0.19
	4G to 6G	> -5.5		± 0.11
	6G to 8G	> -7.0		± 0.09
	8G to 10G	> -8.0		± 0.24
	10G to 14G	> -8.5		± 0.23
	14G to 18G	> -10.0		± 0.29
	18G to 20G	> -11.5		± 0.59

Performance Tests
E5092A Performance Test Record

From Port - To Port	Frequency Range [Hz]	Test Limit [dB]	Test Result [dB]	Measurement Uncertainty [dB]
7COM - 7B	50M to 100M	> -4.0		± 0.27
	100M to 2G	> -3.5		± 0.24
	2G to 3G	> -4.5		± 0.18
	3G to 4G	> -5.0		± 0.19
	4G to 6G	> -5.5		± 0.11
	6G to 8G	> -7.0		± 0.09
	8G to 10G	> -8.0		± 0.24
	10G to 14G	> -8.5		± 0.23
	14G to 18G	> -10.0		± 0.29
	18G to 20G	> -11.5		± 0.59

Isolation

From Common Port to Unselected Port

From Port - To Port (Selected Port)	Frequency Range [Hz]	Test Limit [dB]	Test Result [dB]	Measurement Uncertainty [dB]
7COM - 7A (7B)	50M to 500M	< -65.0		± 0.35
	500M to 1G	< -80.0		± 0.48
	1G to 2G	< -85.0		± 0.60
	2G to 6G	< -90.0		± 0.76
	6G to 10G	< -85.0		± 0.66
	10G to 18G	< -75.0		± 0.54
	18G to 20G	< -65.0		± 0.43
7COM - 7B (7A)	50M to 500M	< -65.0		± 0.35
	500M to 1G	< -80.0		± 0.48
	1G to 2G	< -85.0		± 0.60
	2G to 6G	< -90.0		± 0.76
	6G to 10G	< -85.0		± 0.66
	10G to 18G	< -75.0		± 0.54
	18G to 20G	< -65.0		± 0.43

From Selected Port To Unselected Port

From Port - To Port (Selected Port)	Frequency Range [Hz]	Test Limit [dB]	Test Result [dB]	Measurement Uncertainty [dB]
7A - 7B (7A)	50M to 500M	< -65.0		± 0.35
	500M to 1G	< -80.0		± 0.49
	1G to 2G	< -85.0		± 0.62
	2G to 6G	< -90.0		± 0.71
	6G to 10G	< -85.0		± 0.71
	10G to 18G	< -75.0		± 0.44
	18G to 20G	< -65.0		± 0.36
7B - 7A (7B)	50M to 500M	< -65.0		± 0.35
	500M to 1G	< -80.0		± 0.49
	1G to 2G	< -85.0		± 0.62
	2G to 6G	< -90.0		± 0.71
	6G to 10G	< -85.0		± 0.71
	10G to 18G	< -75.0		± 0.44
	18G to 20G	< -65.0		± 0.36

Load Match, Insertion Loss and Isolation Test for Switch 8 (SPDT, 8COM, 8A and 8B)

Load Match (Unselected)

Port (Selected Port)	Frequency Range [Hz]	Test Limit [dB]	Test Result [dB]	Measurement Uncertainty [dB]
8A (8B)	50M to 3G	< -17.0		± 0.43
	3G to 10G	< -11.0		± 0.37
	10G to 16G	< -8.0		± 0.28
	16G to 18G	< -6.0		± 0.28
	18G to 20G	< -4.0		± 0.35

Load Match (Selected)

Port (Selected Port)	Frequency Range [Hz]	Test Limit [dB]	Test Result [dB]	Measurement Uncertainty [dB]
8A (8A)	50M to 2G	< -17.0		± 0.37
	2G to 4G	< -11.0		± 0.27
	4G to 8G	< -8.0		± 0.18
	8G to 10G	< -7.0		± 0.28
	10G to 18G	< -4.0		± 0.29
	18G to 20G	< -4.0		± 0.29
8B (8B)	50M to 2G	< -17.0		± 0.37
	2G to 4G	< -11.0		± 0.27
	4G to 8G	< -8.0		± 0.18
	8G to 10G	< -7.0		± 0.28
	10G to 18G	< -4.0		± 0.29
	18G to 20G	< -4.0		± 0.29

Load Match (COM)

Port (Selected Port)	Frequency Range [Hz]	Test Limit [dB]	Test Result [dB]	Measurement Uncertainty [dB]
8COM (8A)	50M to 2G	< -16.0		± 0.30
	2G to 4G	< -11.0		± 0.23
	4G to 8G	< -8.0		± 0.12
	8G to 10G	< -7.0		± 0.13
	10G to 20G	< -4.0		± 0.10
8COM (8B)	50M to 2G	< -16.0		± 0.30
	2G to 4G	< -11.0		± 0.23
	4G to 8G	< -8.0		± 0.12
	8G to 10G	< -7.0		± 0.13
	10G to 20G	< -4.0		± 0.10

Insertion Loss

From Port - To Port	Frequency Range [Hz]	Test Limit [dB]	Test Result [dB]	Measurement Uncertainty [dB]
8COM - 8A	50M to 100M	> -4.0		± 0.27
	100M to 2G	> -3.5		± 0.24
	2G to 3G	> -4.5		± 0.18
	3G to 4G	> -5.0		± 0.19
	4G to 6G	> -5.5		± 0.11
	6G to 8G	> -7.0		± 0.09
	8G to 10G	> -8.0		± 0.24
	10G to 14G	> -8.5		± 0.23
	14G to 18G	> -10.0		± 0.29
	18G to 20G	> -11.5		± 0.59

Performance Tests
E5092A Performance Test Record

From Port - To Port	Frequency Range [Hz]	Test Limit [dB]	Test Result [dB]	Measurement Uncertainty [dB]
8COM - 8B	50M to 100M	> -4.0		± 0.27
	100M to 2G	> -3.5		± 0.24
	2G to 3G	> -4.5		± 0.18
	3G to 4G	> -5.0		± 0.19
	4G to 6G	> -5.5		± 0.11
	6G to 8G	> -7.0		± 0.09
	8G to 10G	> -8.0		± 0.24
	10G to 14G	> -8.5		± 0.23
	14G to 18G	> -10.0		± 0.29
	18G to 20G	> -11.5		± 0.59

Isolation

From Common Port to Unselected Port

From Port - To Port (Selected Port)	Frequency Range [Hz]	Test Limit [dB]	Test Result [dB]	Measurement Uncertainty [dB]
8COM - 8A (8B)	50M to 500M	< -65.0		± 0.35
	500M to 1G	< -80.0		± 0.48
	1G to 2G	< -85.0		± 0.60
	2G to 6G	< -90.0		± 0.76
	6G to 10G	< -85.0		± 0.66
	10G to 18G	< -75.0		± 0.54
	18G to 20G	< -65.0		± 0.43
8COM - 8B (8A)	50M to 500M	< -65.0		± 0.35
	500M to 1G	< -80.0		± 0.48
	1G to 2G	< -85.0		± 0.60
	2G to 6G	< -90.0		± 0.76
	6G to 10G	< -85.0		± 0.66
	10G to 18G	< -75.0		± 0.54
	18G to 20G	< -65.0		± 0.43

From Selected Port To Unselected Port

From Port - To Port (Selected Port)	Frequency Range [Hz]	Test Limit [dB]	Test Result [dB]	Measurement Uncertainty [dB]
8A - 8B (8A)	50M to 500M	< -65.0		± 0.35
	500M to 1G	< -80.0		± 0.49
	1G to 2G	< -85.0		± 0.62
	2G to 6G	< -90.0		± 0.71
	6G to 10G	< -85.0		± 0.71
	10G to 18G	< -75.0		± 0.44
	18G to 20G	< -65.0		± 0.36
8B - 8A (8B)	50M to 500M	< -65.0		± 0.35
	500M to 1G	< -80.0		± 0.49
	1G to 2G	< -85.0		± 0.62
	2G to 6G	< -90.0		± 0.71
	6G to 10G	< -85.0		± 0.71
	10G to 18G	< -75.0		± 0.44
	18G to 20G	< -65.0		± 0.36

Load Match, Insertion Loss and Isolation Test for Switch 9 (SPDT, 9COM, 9A and 9B)

Load Match (Unselected)

Port (Selected Port)	Frequency Range [Hz]	Test Limit [dB]	Test Result [dB]	Measurement Uncertainty [dB]
9A (9B)	50M to 3G	< -17.0		± 0.43
	3G to 10G	< -11.0		± 0.37
	10G to 16G	< -8.0		± 0.28
	16G to 18G	< -6.0		± 0.28
	18G to 20G	< -4.0		± 0.35

Load Match (Selected)

Port (Selected Port)	Frequency Range [Hz]	Test Limit [dB]	Test Result [dB]	Measurement Uncertainty [dB]
9A (9A)	50M to 2G	< -17.0		± 0.37
	2G to 4G	< -11.0		± 0.27
	4G to 8G	< -8.0		± 0.18
	8G to 10G	< -7.0		± 0.28
	10G to 18G	< -4.0		± 0.29
	18G to 20G	< -4.0		± 0.29
9B (9B)	50M to 2G	< -17.0		± 0.37
	2G to 4G	< -11.0		± 0.27
	4G to 8G	< -8.0		± 0.18
	8G to 10G	< -7.0		± 0.28
	10G to 18G	< -4.0		± 0.29
	18G to 20G	< -4.0		± 0.29

Load Match (COM)

Port (Selected Port)	Frequency Range [Hz]	Test Limit [dB]	Test Result [dB]	Measurement Uncertainty [dB]
9COM (9A)	50M to 2G	< -16.0		± 0.30
	2G to 4G	< -11.0		± 0.23
	4G to 8G	< -8.0		± 0.12
	8G to 10G	< -7.0		± 0.13
	10G to 20G	< -4.0		± 0.10
9COM (9B)	50M to 2G	< -16.0		± 0.30
	2G to 4G	< -11.0		± 0.23
	4G to 8G	< -8.0		± 0.12
	8G to 10G	< -7.0		± 0.13
	10G to 20G	< -4.0		± 0.10

Insertion Loss

From Port - To Port	Frequency Range [Hz]	Test Limit [dB]	Test Result [dB]	Measurement Uncertainty [dB]
9COM - 9A	50M to 100M	> -4.0		± 0.27
	100M to 2G	> -3.5		± 0.24
	2G to 3G	> -4.5		± 0.18
	3G to 4G	> -5.0		± 0.19
	4G to 6G	> -5.5		± 0.11
	6G to 8G	> -7.0		± 0.09
	8G to 10G	> -8.0		± 0.24
	10G to 14G	> -8.5		± 0.23
	14G to 18G	> -10.0		± 0.29
	18G to 20G	> -11.5		± 0.59

Performance Tests
E5092A Performance Test Record

From Port - To Port	Frequency Range [Hz]	Test Limit [dB]	Test Result [dB]	Measurement Uncertainty [dB]
9COM - 9B	50M to 100M	> -4.0		± 0.27
	100M to 2G	> -3.5		± 0.24
	2G to 3G	> -4.5		± 0.18
	3G to 4G	> -5.0		± 0.19
	4G to 6G	> -5.5		± 0.11
	6G to 8G	> -7.0		± 0.09
	8G to 10G	> -8.0		± 0.24
	10G to 14G	> -8.5		± 0.23
	14G to 18G	> -10.0		± 0.29
	18G to 20G	> -11.5		± 0.59

Isolation

From Common Port to Unselected Port

From Port - To Port (Selected Port)	Frequency Range [Hz]	Test Limit [dB]	Test Result [dB]	Measurement Uncertainty [dB]
9COM - 9A (9B)	50M to 500M	< -65.0		± 0.35
	500M to 1G	< -80.0		± 0.48
	1G to 2G	< -85.0		± 0.60
	2G to 6G	< -90.0		± 0.76
	6G to 10G	< -85.0		± 0.66
	10G to 18G	< -75.0		± 0.54
	18G to 20G	< -65.0		± 0.43
9COM - 9B (9A)	50M to 500M	< -65.0		± 0.35
	500M to 1G	< -80.0		± 0.48
	1G to 2G	< -85.0		± 0.60
	2G to 6G	< -90.0		± 0.76
	6G to 10G	< -85.0		± 0.66
	10G to 18G	< -75.0		± 0.54
	18G to 20G	< -65.0		± 0.43

From Selected Port To Unselected Port

From Port - To Port (Selected Port)	Frequency Range [Hz]	Test Limit [dB]	Test Result [dB]	Measurement Uncertainty [dB]
9A - 9B (9A)	50M to 500M	< -65.0		± 0.35
	500M to 1G	< -80.0		± 0.49
	1G to 2G	< -85.0		± 0.62
	2G to 6G	< -90.0		± 0.71
	6G to 10G	< -85.0		± 0.71
	10G to 18G	< -75.0		± 0.44
	18G to 20G	< -65.0		± 0.36
9B - 9A (9B)	50M to 500M	< -65.0		± 0.35
	500M to 1G	< -80.0		± 0.49
	1G to 2G	< -85.0		± 0.62
	2G to 6G	< -90.0		± 0.71
	6G to 10G	< -85.0		± 0.71
	10G to 18G	< -75.0		± 0.44
	18G to 20G	< -65.0		± 0.36

Load Match, Insertion Loss and Isolation Test for Switch 10(SPDT, 10COM, 10A and 10B)

Load Match (Unselected)

Port (Selected Port)	Frequency Range [Hz]	Test Limit [dB]	Test Result [dB]	Measurement Uncertainty [dB]
10A (10B)	50M to 3G	< -17.0		± 0.43
	3G to 10G	< -11.0		± 0.37
	10G to 16G	< -8.0		± 0.28
	16G to 18G	< -6.0		± 0.28
	18G to 20G	< -4.0		± 0.35

Load Match (Selected)

Port (Selected Port)	Frequency Range [Hz]	Test Limit [dB]	Test Result [dB]	Measurement Uncertainty [dB]
10A (10A)	50M to 2G	< -17.0		± 0.37
	2G to 4G	< -11.0		± 0.27
	4G to 8G	< -8.0		± 0.18
	8G to 10G	< -7.0		± 0.28
	10G to 18G	< -4.0		± 0.29
	18G to 20G	< -4.0		± 0.29
10B (10B)	50M to 2G	< -17.0		± 0.37
	2G to 4G	< -11.0		± 0.27
	4G to 8G	< -8.0		± 0.18
	8G to 10G	< -7.0		± 0.28
	10G to 18G	< -4.0		± 0.29
	18G to 20G	< -4.0		± 0.29

Load Match (COM)

Port (Selected Port)	Frequency Range [Hz]	Test Limit [dB]	Test Result [dB]	Measurement Uncertainty [dB]
10COM (10A)	50M to 2G	< -16.0		± 0.30
	2G to 4G	< -11.0		± 0.23
	4G to 8G	< -8.0		± 0.12
	8G to 10G	< -7.0		± 0.13
	10G to 20G	< -4.0		± 0.10
10COM (10B)	50M to 2G	< -16.0		± 0.30
	2G to 4G	< -11.0		± 0.23
	4G to 8G	< -8.0		± 0.12
	8G to 10G	< -7.0		± 0.13
	10G to 20G	< -4.0		± 0.10

Insertion Loss

From Port - To Port	Frequency Range [Hz]	Test Limit [dB]	Test Result [dB]	Measurement Uncertainty [dB]
10COM - 10A	50M to 100M	> -4.0		± 0.27
	100M to 2G	> -3.5		± 0.24
	2G to 3G	> -4.5		± 0.18
	3G to 4G	> -5.0		± 0.19
	4G to 6G	> -5.5		± 0.11
	6G to 8G	> -7.0		± 0.09
	8G to 10G	> -8.0		± 0.24
	10G to 14G	> -8.5		± 0.23
	14G to 18G	> -10.0		± 0.29
	18G to 20G	> -11.5		± 0.59

Performance Tests
E5092A Performance Test Record

From Port - To Port	Frequency Range [Hz]	Test Limit [dB]	Test Result [dB]	Measurement Uncertainty [dB]
10COM - 10B	50M to 100M	> -4.0		± 0.27
	100M to 2G	> -3.5		± 0.24
	2G to 3G	> -4.5		± 0.18
	3G to 4G	> -5.0		± 0.19
	4G to 6G	> -5.5		± 0.11
	6G to 8G	> -7.0		± 0.09
	8G to 10G	> -8.0		± 0.24
	10G to 14G	> -8.5		± 0.23
	14G to 18G	> -10.0		± 0.29
	18G to 20G	> -11.5		± 0.59

Isolation

From Common Port to Unselected Port

From Port - To Port (Selected Port)	Frequency Range [Hz]	Test Limit [dB]	Test Result [dB]	Measurement Uncertainty [dB]
10COM - 10A (10B)	50M to 500M	< -65.0		± 0.35
	500M to 1G	< -80.0		± 0.48
	1G to 2G	< -85.0		± 0.60
	2G to 6G	< -90.0		± 0.76
	6G to 10G	< -85.0		± 0.66
	10G to 18G	< -75.0		± 0.54
	18G to 20G	< -65.0		± 0.43
10COM - 10B (10A)	50M to 500M	< -65.0		± 0.35
	500M to 1G	< -80.0		± 0.48
	1G to 2G	< -85.0		± 0.60
	2G to 6G	< -90.0		± 0.76
	6G to 10G	< -85.0		± 0.66
	10G to 18G	< -75.0		± 0.54
	18G to 20G	< -65.0		± 0.43

From Selected Port To Unselected Port

From Port - To Port (Selected Port)	Frequency Range [Hz]	Test Limit [dB]	Test Result [dB]	Measurement Uncertainty [dB]
10A - 10B (10A)	50M to 500M	< -65.0		± 0.35
	500M to 1G	< -80.0		± 0.49
	1G to 2G	< -85.0		± 0.62
	2G to 6G	< -90.0		± 0.71
	6G to 10G	< -85.0		± 0.71
	10G to 18G	< -75.0		± 0.44
	18G to 20G	< -65.0		± 0.36
10B - 10A (10B)	50M to 500M	< -65.0		± 0.35
	500M to 1G	< -80.0		± 0.49
	1G to 2G	< -85.0		± 0.62
	2G to 6G	< -90.0		± 0.71
	6G to 10G	< -85.0		± 0.71
	10G to 18G	< -75.0		± 0.44
	18G to 20G	< -65.0		± 0.36

Control Line Maximum Current Test

Control Line Group	Lower Test Limit [mA]	Test Result [mA]	Measurement Uncertainty [mA]
A	≥ 50		± 0.008856
B	≥ 50		± 0.008856
C	≥ 0.5		± 0.000046
D	≥ 0.5		± 0.000046

Performance Tests
E5092A Performance Test Record

3 Troubleshooting

This chapter provides procedure to isolate a faulty assembly in the E5092A.

Introduction

WARNING These servicing instructions are for use by qualified personnel only. To avoid possible electrical shock, do not perform any servicing unless you are qualified to do so.

WARNING The opening of covers or removal of parts is likely to expose dangerous voltages. Disconnect the instrument from its power supply beforehand.

CAUTION Many of the assemblies in the instrument are very susceptible to damage from ESD (electrostatic discharge). Perform the following procedures only at a static-safe workstation and wear a grounding strap.

To Troubleshoot the E5092A

This section describes typical troubleshooting procedure when servicing the E5092A. The information in this chapter helps you to identify the portion of the E5092A that is at fault.

Figure 3-1 shows the block diagram of the E5092A.

Figure 3-1 Block diagram of the E5092A

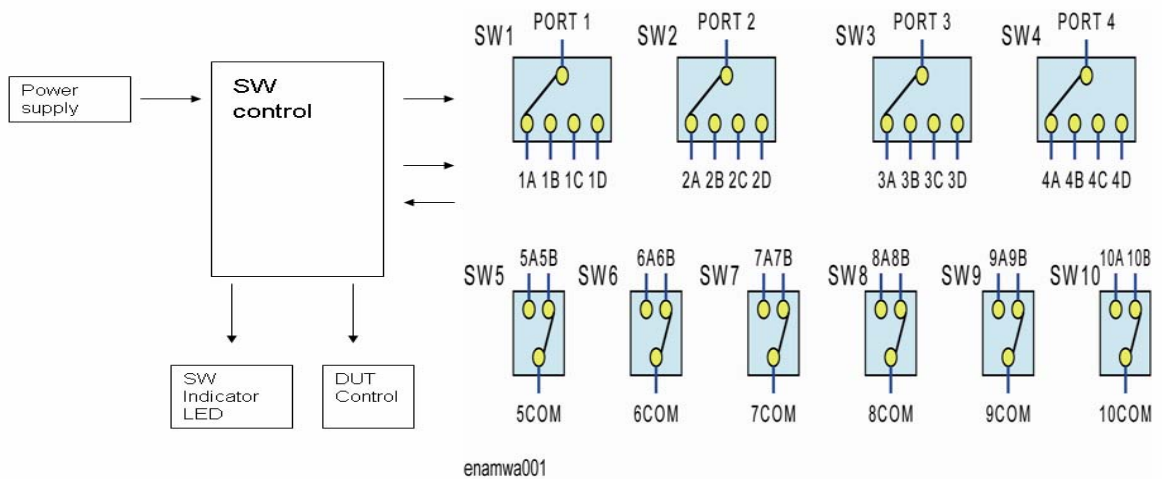

Primary Trouble Isolation

The primary trouble isolation in Figure 3-2 is to help direct you to the correct section for troubleshooting the E5092A.

Step 1. Turn the E5092A power on

After the E5092A is turned on, all the LEDs of A connection on the Port Connection should be lit. In case of unexpected results, go to “Power Supply Troubleshooting” .

Step 2. Check the E5092A setting with E5071C

If the E5092A setting does not work correctly, go to “E5092A setting Troubleshooting”

Step 3. Check the measurement function (port characteristics)

If the E5092A fails performance tests, go to “Performance Test failure Troubleshooting”.

A faulty part is replaced according to Chapter 5 which gives replacement procedures for the parts. The procedure required after part replacement are given in Chapter 6.

Figure 3-2

Primary trouble isolation flowchart

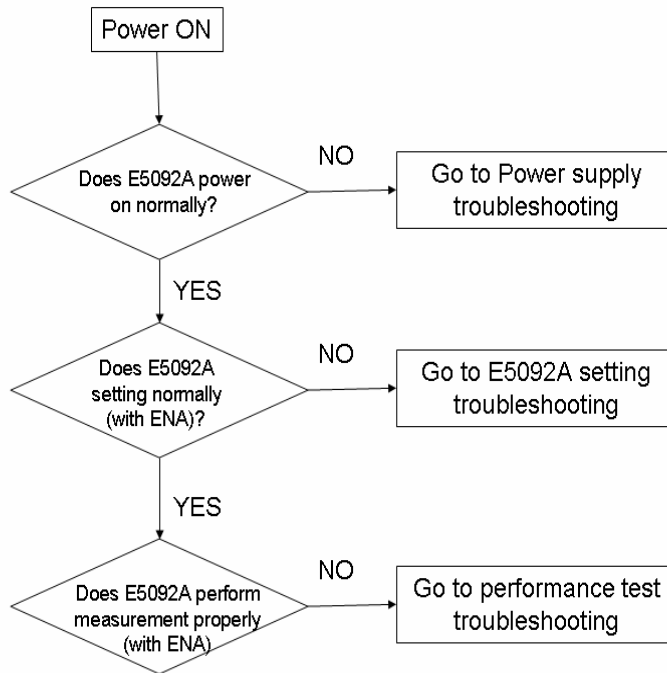

Power Supply Troubleshooting

Check the Line Voltage and Fuse

Check the main power line cord, line fuse, actual line voltage to see that they are all correct. For more information about the line cord and Line fuse, see the Power Requirements in Appendix B.

Check the Power Supply Unit Output

- Step 1.** Remove the E5092A's outer cover.
- Step 2.** Turn the E5092A power on.
- Step 3.** Measure the output voltage (+5, +15, -15 V) of the power supply unit using a voltmeter with a small probe. The voltages locations on the A1 Switch control board are shown in Figure 3-3.

Figure 3-3 Output Voltage Location

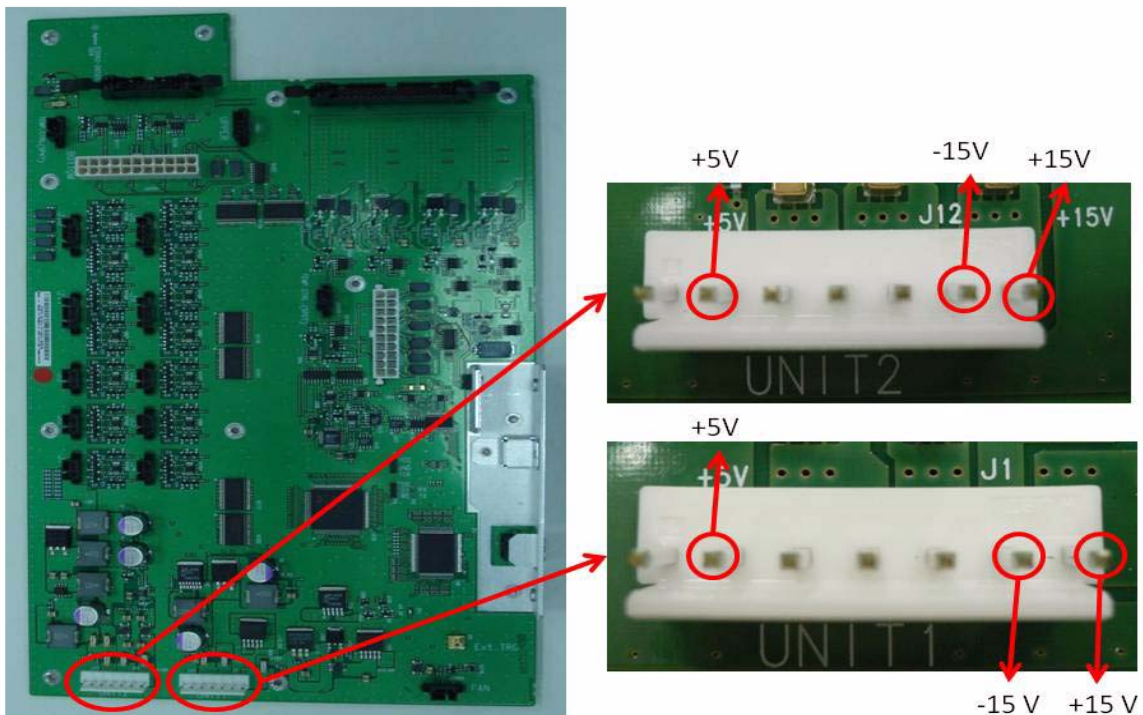

- If the voltmeter reading is not within the following limits, replace the power supply

Troubleshooting
Power Supply Troubleshooting

unit.

Table 3-1

Power Supply Unit Output

supply	Range
+ 5 V	+ 4.75 to + 5.25
+ 15 V	+ 14.25 to 15.75
- 15 V	- 14.25 to -15.75

- If the voltmeter reading is within the limits, the power supply is verified.

E5092A Setting Troubleshooting

Check the E5092A Setting

- Step 1.** Connect the USB cable furnished with E5092A between the rear panel of the E5071C and that of the E5092A.
- Step 2.** Turn on the E5071C and the E5092A.
- Step 3.** Immediately, after power-on, LEDs of port A for all port connection of the E5092A go on.

NOTE If the E5071C is not powered on or if the E5071C and the E5092A are not connected with the USB cable, LEDs of port A for all port connection of the E5092A stay off

- Step 4.** Press **[System]** - **Multiport Test Set Setup - Test Set 1** to display the Test Set 1 menu.
- Step 5.** Press **Control** to enable (**ON**) the control of the E5092A.

NOTE The enable (**ON**)/disable (**OFF**) setting of the control function of the E5092A is executed for all channels.

- Step 6.** Press **Property** to enable (**ON**) the control of the E5092A as shown in Figure 3-4.

Figure 3-4 E5092A property

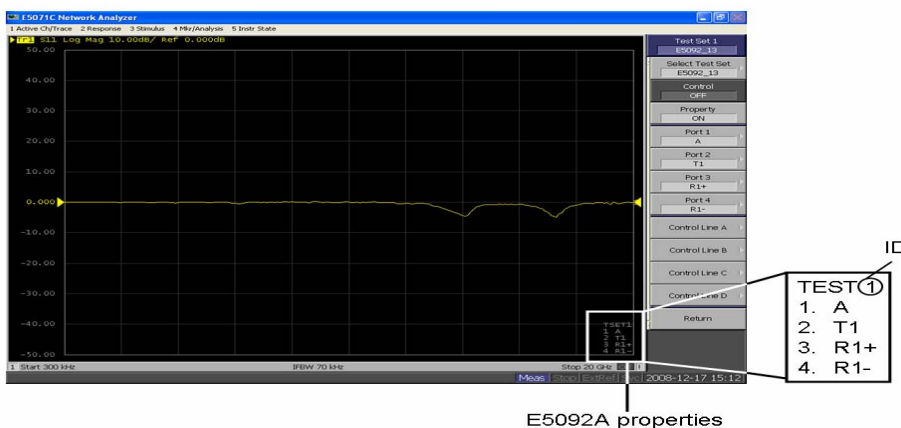

NOTE The enable (**ON**)/disable (**OFF**) setting of the E5092A property display is executed for all channels.

- Step 7.** Use the corresponding softkey to assign between the test ports of the E5092A and the

Troubleshooting
E5092A Setting Troubleshooting

interconnection ports.

Softkey	Function
Port1	Selects a test port of the E5092A to which you want to connect port 1 of the E5092A. You can select the port from A, T1, T2 or T3 .
Port2	Selects a test port of the E5092A to which you want to connect port 2 of the E5092A. You can select the port from T1, T2, T3 or T4 .
Port3	Selects a test port of the E5092A to which you want to connect port 3 of the E5092A. You can select the port from R1+, R2+, R3+ or R4+
Port4	Selects a test port of the E5092A to which you want to connect port 4 of the E5092A. You can select the port from R1-, R2-, R3- or R4- .

Step 8. Check that the LEDs on the Port Connection Indicator are the same ports as the E5092A property display.

- If any of the ports setting are different from the E5092A property display, the A1 board is suspect.
- If all the ports are good, the A1 board is verified.

Check the temperature control

Step 1. Connect the USB cable furnished with E5092A between the rear panel of the E5071C and that of the E5092A.

Step 2. Turn on the E5071C and the E5092A. Allow them to warm up for at least 30 minutes before you proceed the next step.

Step 3. Press **[System]** - **Service Menu** - **Service Functions**. Then password dialog box will appear. Enter the password **kid** in the password box and then click **OK** button.

Step 4. Press **E5092A Service Functions - E5092A ID(1)**.

Step 5. Press **E5092A**, and then check that values on ADC1 and ADC2 are within the following limits.

NOTE

The values on ADC1 and ADC2 are not measured continuously. The values are measured when E5092A, **ADC1**, or **ADC2** softkey is pressed.

Table 3-2

ADC Voltage

ADC	Range
ADC1	+ 2.0 to + 2.3 V
ADC2	+ 1.5 to + 2.6 V

- If the voltage of ADC1 is not within the limit, the A1board or the heat sensor is

suspect.

- If the voltage of ADC2 is not within the limit, the A1 board or the heater is suspect.

Check the voltage output of the Control Lines

Step 1. Turn on the E5092A.

Step 2. Measure the DC voltage between the pin 12 and 15 on the control lines using a voltmeter with a small probe. Figure 3-5 shows the pin assignment of the control lines.

Figure 3-5

Pin assignment of the control lines

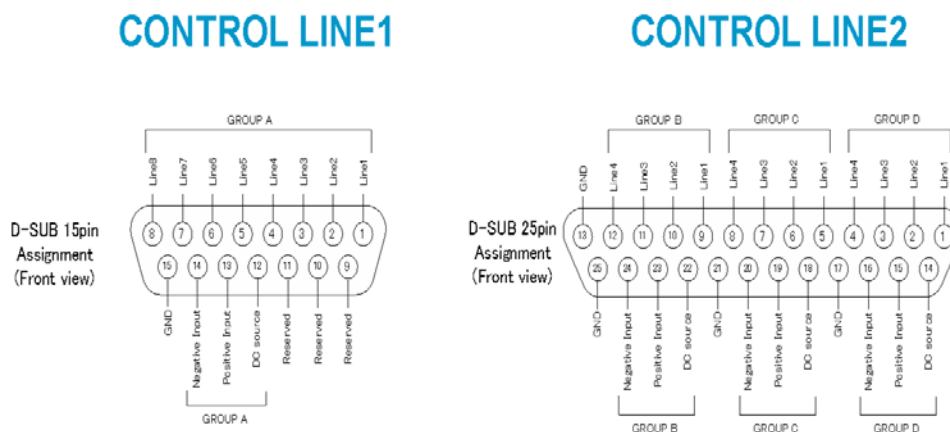

Step 3. Rotate the voltage adjustment trimmer on the front panel. Check that the trimmer can set the voltage from +2V to +5V.

- If the output voltage can not be varied from +2V to +5V though the A1 board works correctly, the A3 DUT control board is suspect.
- If the output voltage is good, the A3 board is verified.

Check control lines setting

The E5092A can control the output from the control line (Figure 3-5) of the E5092A and control the DUT (for example, switching the frequency band of the front end module).

Step 1. Short between the pin 12 - 13 and the pin 14 - 15.

Step 2. Press **System** - **Multiport Test Set Setup** to display the Multiport Test Set Setup menu.

Step 3. Press **Test Set 1** and then select the ID of the E5092A. The ID is set with the bit switch on the real panel of the E5092A.

Step 4. Press **Control Lines** from group A until group D to the setting menu of the DUT control line.

Troubleshooting
E5092A Setting Troubleshooting

Step 5. Use the corresponding softkey to set the control line of the E5092A.

Softkey	Function
Line 1, Line 2, Line 3, Line 4, Line 5, Line 6, Line 7, Line 8	Set High/Low of each line of the control line.

Step 6. Measure the DC voltages of the control lines using a voltmeter with a small probe. If **High** is set for each control line, the voltage of the control line is the same value as the output voltage of the pin 12. If **Low** is set for each control line, the voltage of the control line is the same value as the output voltage of the pin 15.

- If any of the voltages of the control lines are not the same voltages as the pin 12 or pin 15, the A3 board is suspect.
- If all the voltages of the control lines are good, the A3 board is verified.

Performance Test Failure Troubleshooting

Performance Test failure troubleshooting information

Table 3-3 represents the relationships between the failed test and probable faulty assembly. Note that this table lists some typical cases. There are possibilities that other assembly may be faulty.

Table 3-3 Performance test failure troubleshooting information

Failed Test	Probable faulty board assembly or parts
DC Source Output Voltage Accuracy Test	SW Control USB PCA (E5092-66601) / SW Indicator LED PCA (E5092-66602) / DUT Control PCA (E5092-66603)
DC Source Maximum Current Test	SW Control USB PCA (E5092-66601) / SW Indicator LED PCA (E5092-66602) / DUT Control PCA (E5092-66603)
Load Match, Insertion Loss and Isolation Test for Switch 1(SP4T, Port1, 1A, 1B, 1C and 1D)	Switch 1 (SP4T)
Load Match, Insertion Loss and Isolation Test for Switch 2(SP4T, Port2, 2A, 2B, 2C and 2D)	Switch 2 (SP4T)
Load Match, Insertion Loss and Isolation Test for Switch 3(SP4T, Port3, 3A, 3B, 3C and 3D)	Switch 3 (SP4T)
Load Match, Insertion Loss and Isolation Test for Switch 4(SP4T, Port4, 4A, 4B, 4C and 4D)	Switch 4 (SP4T)
Load Match, Insertion Loss and Isolation Test for Switch 5(SPDT, 5COM, 5A and 5B)	Switch 5 (SPDT)
Load Match, Insertion Loss and Isolation Test for Switch 6(SPDT, 6COM, 6A and 6B)	Switch 6 (SPDT)
Load Match, Insertion Loss and Isolation Test for Switch 7(SPDT, 7COM, 7A and 7B)	Switch 7 (SPDT)
Load Match, Insertion Loss and Isolation Test for Switch 8(SPDT, 8COM, 8A and 8B)	Switch 8 (SPDT)
Load Match, Insertion Loss and Isolation Test for Switch 9(SPDT, 9COM, 9A and 9B)	Switch 9 (SPDT)
Load Match, Insertion Loss and Isolation Test for Switch 10(SPDT, 10COM, 10A and 10B)	Switch 10 (SPDT)
Control Line Maximum Current Test	SW Control USB PCA (E5092-66601) / SW Indicator LED PCA (E5092-66602) / DUT Control PCA (E5092-66603)

Troubleshooting

Performance Test Failure Troubleshooting

4 Replaceable Parts

This chapter contains information for ordering replacement parts for the E5092A.

Ordering Information

To order parts listed in the replaceable part lists, quote the Agilent part number (with a check digit), indicate the quantity required, and address the order to the nearest Agilent office. The check digit will ensure accurate and timely processing of the order.

To order a part not listed in the replaceable part table, include the instrument model number, the description and function of the part, and the quantity of parts required. Address the order to the nearest Agilent office.

Direct Mail Order System

Within the USA, Agilent can supply parts through a direct mail order system. There are several advantages to this system:

- Direct ordering and shipping from the Agilent Parts Center in Mountain View, California.
- No maximum or minimum on any mail order (there is a minimum order amount for parts ordered through a local Agilent office when the orders require billing and invoicing)
- Prepaid transportation (there is a small handling charge for each order).
- No invoices.

In order for Agilent to provide these advantages, please send a check or money order with each order.

Mail order forms and specific ordering information are available through your local Agilent sales office. Addresses and telephone numbers are located in a separate document shipped with the manuals.

Replaceable Parts List for E5092A-020

Top View (Major Assemblies)

Figure 4-1 Top View (Major Assemblies)

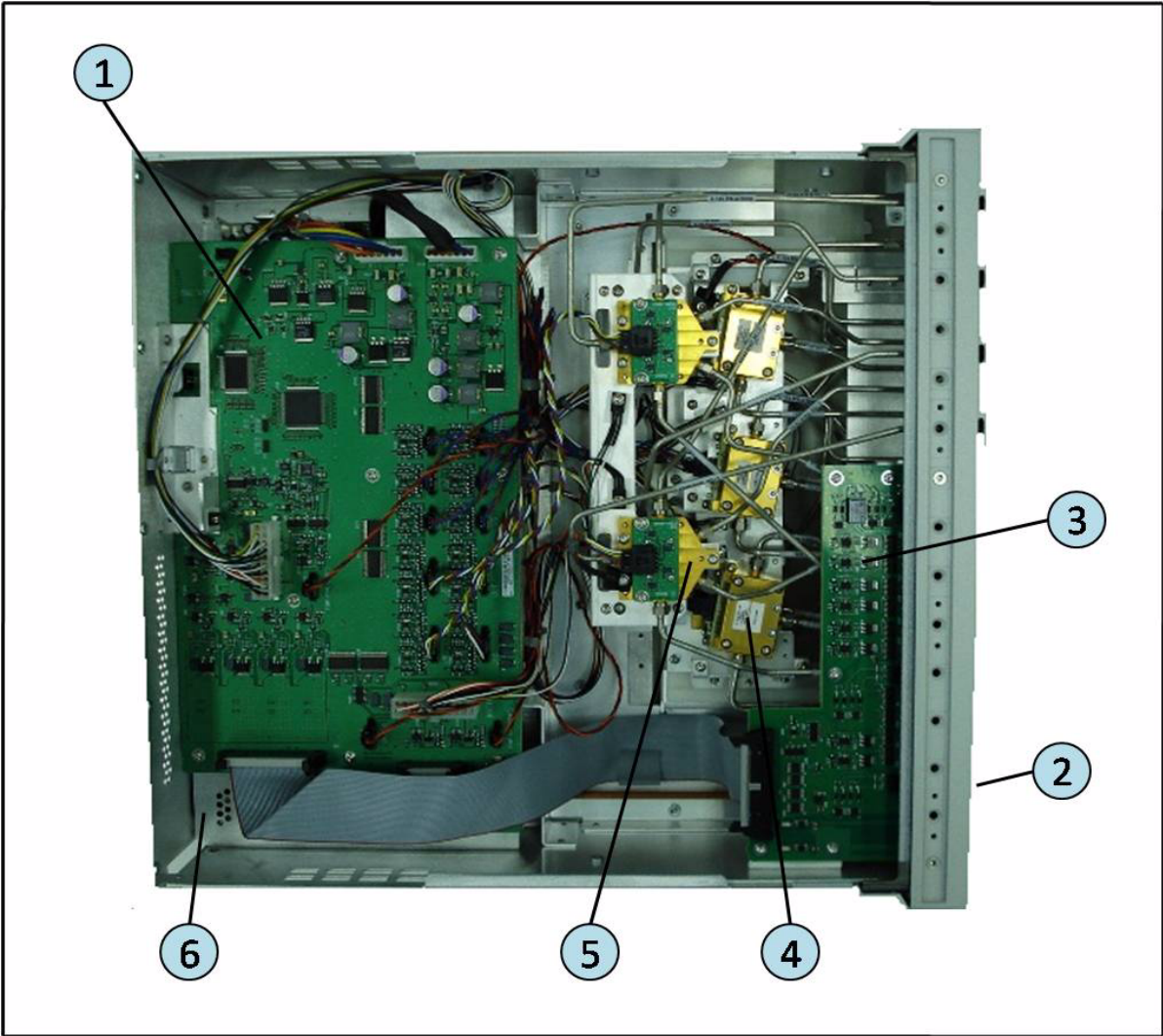

4. Replaceable Parts

Replaceable Parts
Replaceable Parts List for E5092A-020

Table 4-1 **Top View (Major Assemblies)**

Ref. Desig.	Agilent Part Number	Qty.	Description
1	E5092-66601	1	SWITCH CONTROL USB PCA
2	E5092-66602	1	SWITCH INDICATOR LED PCA
3	E5092-66603	1	DUT CONTROL PCA
4	P9397-60001	6	20GHz SPDT PIN SWITCH MODULE
5	P9398-60001	4	20GHz SP4T PIN SWITCH MODULE
6	E5092-00103	1	RF SW CHASSIS

Top View (Major Assemblies) (Under Switch Control USB PCA)

Figure 4-2

Top View (Major Assemblies) (Under Switch Control USB PCA)

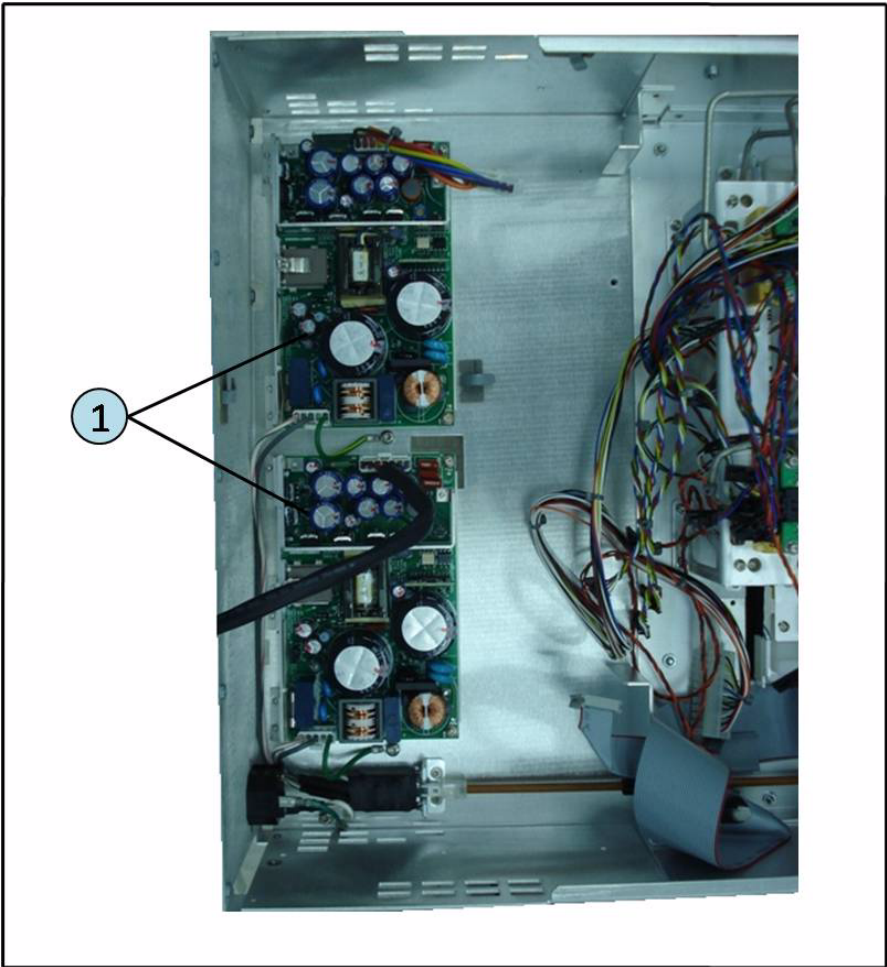

Table 4-2

Top View (Major Assemblies) (Under Switch Control USB PCA)

Ref. Desig.	Agilent Part Number	Qty.	Description
1	0950-3642	2	POWER SUPPLY 50-WATT 3-OUTPUT

Top View (Cables)

Figure 4-3 Top View (Cables)

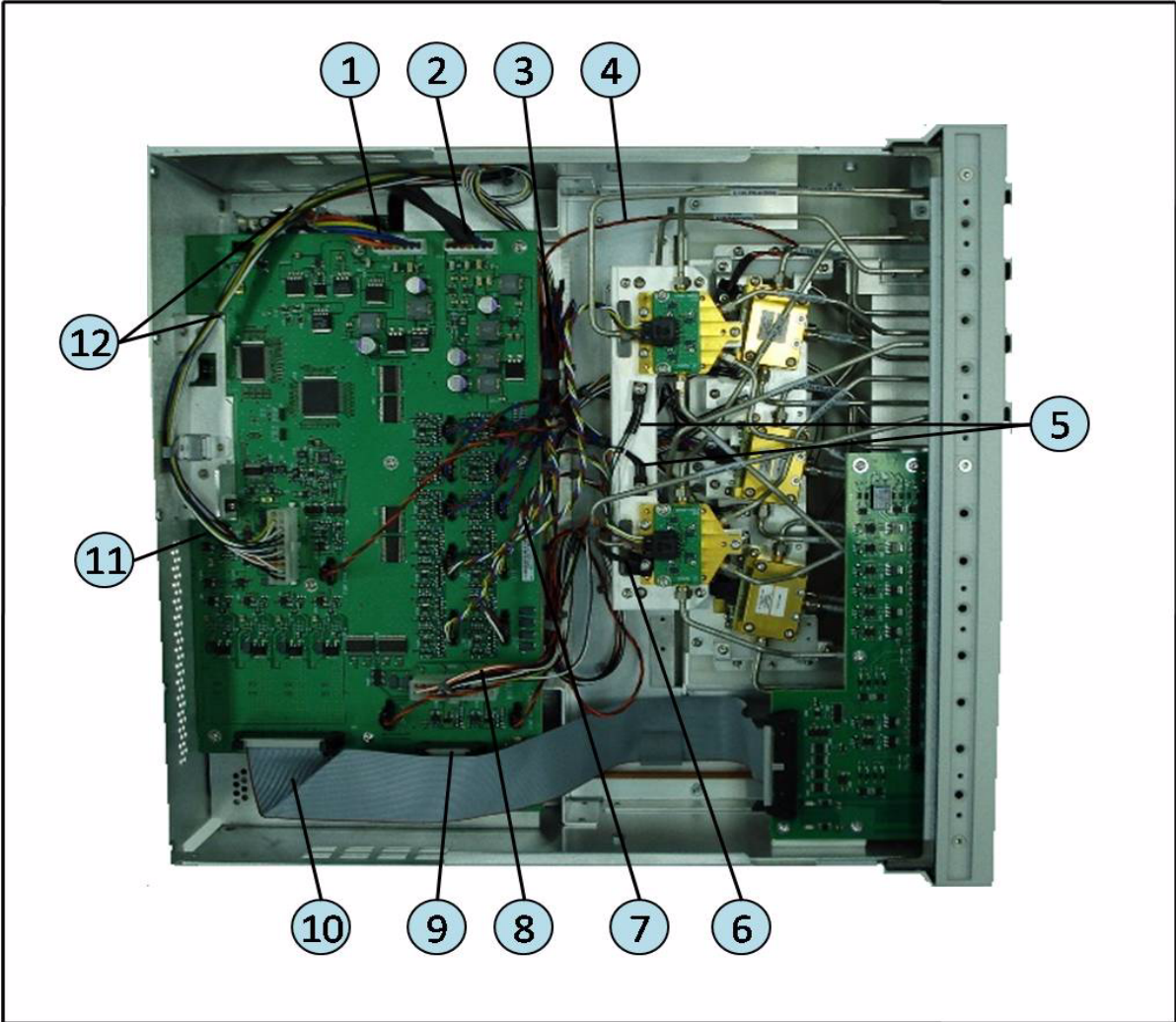

Table 4-3 Top View (Cables)

Ref. Desig.	Agilent Part Number	Qty.	Description
1	E5092-61604	1	WIRE ASSY
2	E5092-61605	1	WIRE ASSY
3	E5092-61603	6	WIRE ASSY
4	E5092-61647	1	WIRE ASSY
5	E5092-61645	2	WIRE ASSY
6	E5092-61656	1	WIRE ASSY
7	E5092-61601	4	WIRE ASSY
8	E5092-61645	1	WIRE ASSY
9	E5092-61607	1	FLAT CABLE ASSY
10	E5092-61606	1	FLAT CABLE ASSY
11	E5092-61646	1	WIRE ASSY
12	1400-0493		CABLE TIE

Top View (Cables) (Under Switch Control USB PCA)

Figure 4-4

Top View (Cables) (Under Switch Control USB PCA)

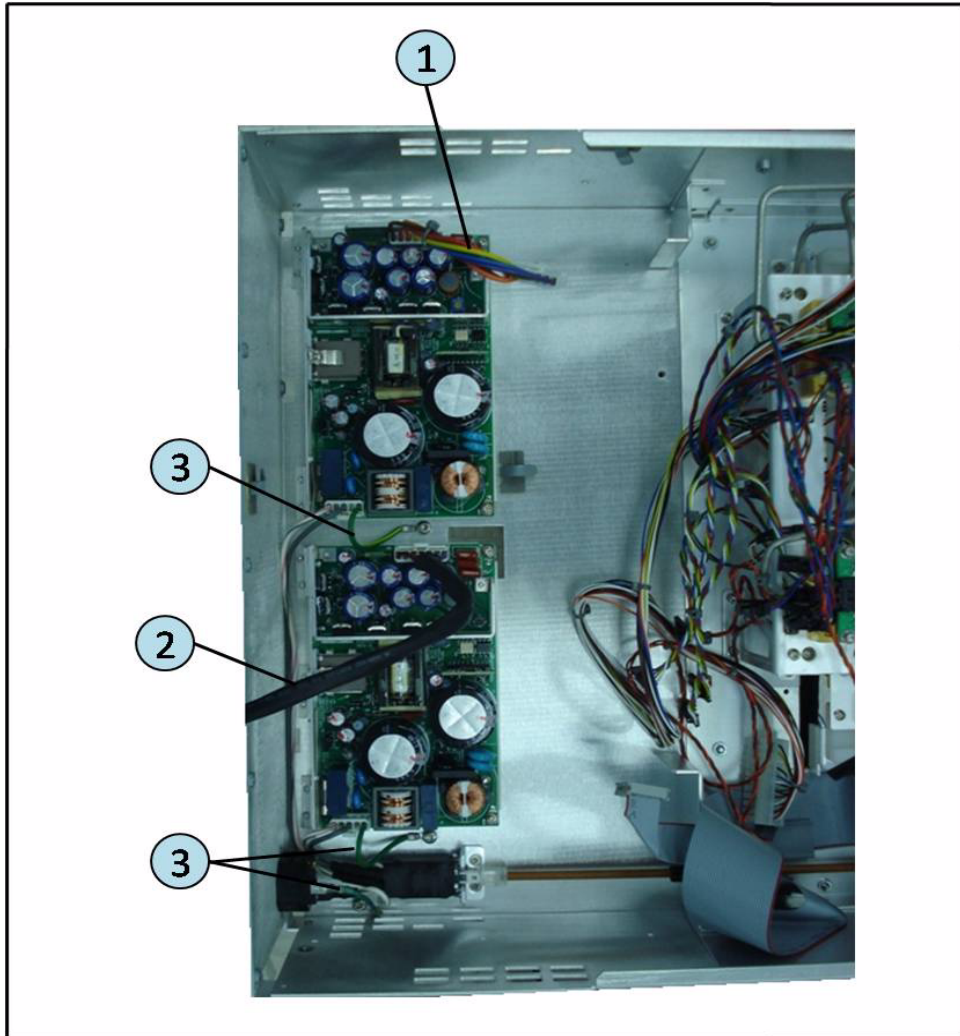
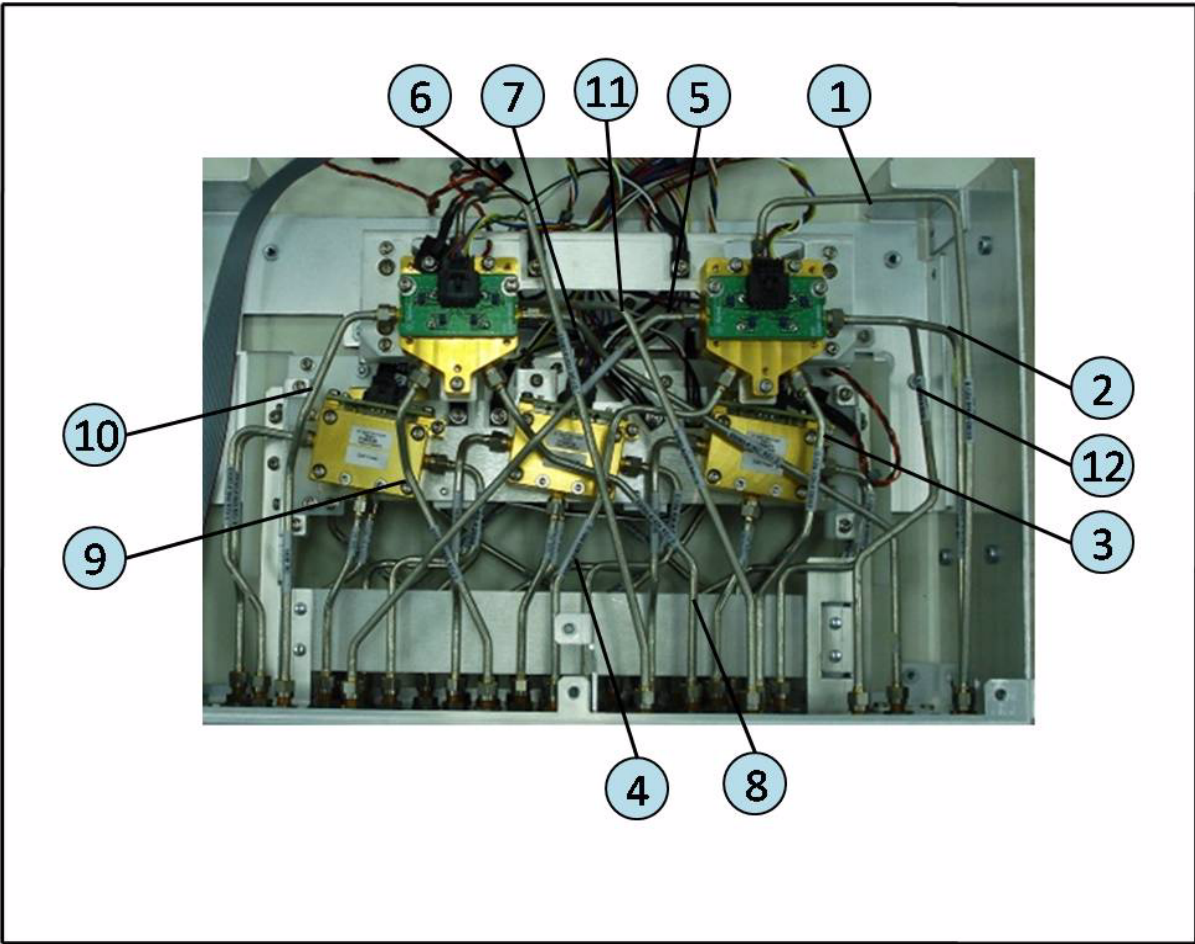

Table 4-4 Top View (Cables) (Under Switch Control USB PCA)

Ref. Desig.	Agilent Part Number	Qty.	Description
1	E5092-61604	1	WIRE ASSY
2	E5092-61605	1	WIRE ASSY
3	04288-61633	1	WIRE ASSY

Top View (Semirigid Cables) (SP4T)

Figure 4-5 Top View (Semirigid Cables) (SP4T)



Replaceable Parts
Replaceable Parts List for E5092A-020

Table 4-5 **Top View (Semirigid Cables) (SP4T)**

Ref. Desig.	Agilent Part Number	Qty.	Description
1	E5092-61649	1	RF CABLE ASSY SEMI-RIGID
2	E5092-61616	1	RF CABLE ASSY SEMI-RIGID
3	E5092-61621	1	RF CABLE ASSY SEMI-RIGID
4	E5092-61622	1	RF CABLE ASSY SEMI-RIGID
5	E5092-61623	1	RF CABLE ASSY SEMI-RIGID
6	E5092-61631	1	RF CABLE ASSY SEMI-RIGID
7	E5092-61627	1	RF CABLE ASSY SEMI-RIGID
8	E5092-61624	1	RF CABLE ASSY SEMI-RIGID
9	E5092-61625	1	RF CABLE ASSY SEMI-RIGID
10	E5092-61626	1	RF CABLE ASSY SEMI-RIGID
11	E5092-61630	1	RF CABLE ASSY SEMI-RIGID
12	E5092-61648	1	RF CABLE ASSY SEMI-RIGID

Top View (Semirigid Cables) (SPDT)

Figure 4-6 Top View (Semirigid Cables) (SPDT)

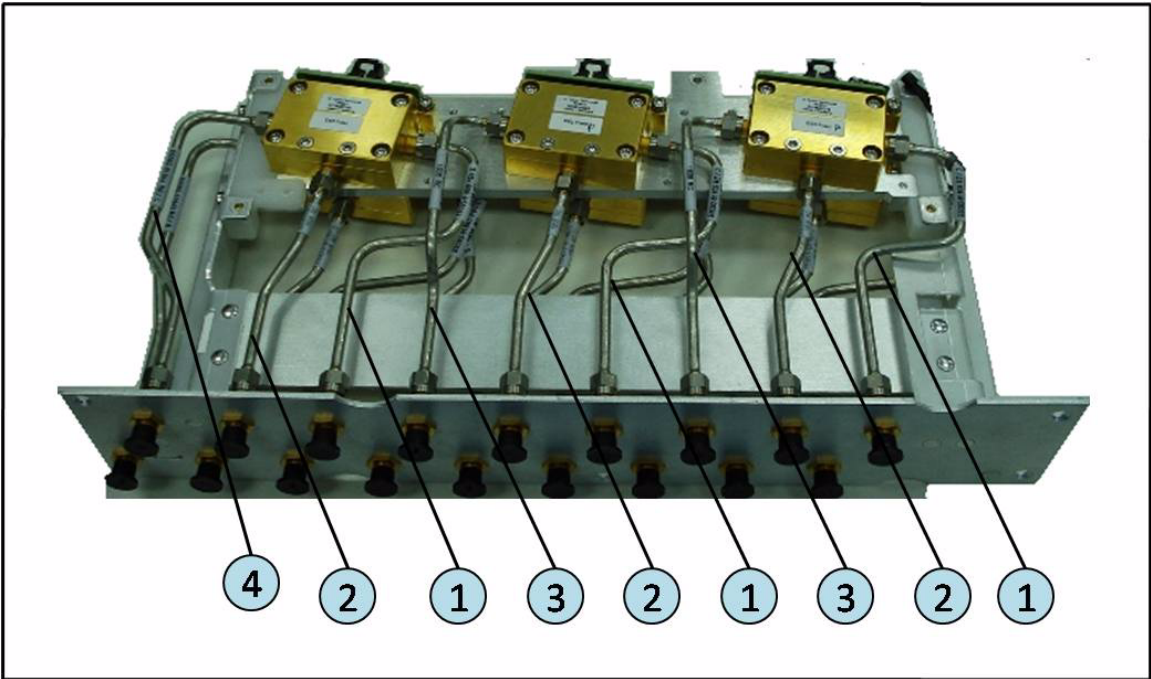

Table 4-6 Top View (Semirigid Cables) (SPDT)

Ref. Desig.	Agilent Part Number	Qty.	Description
1	E5092-61609	3	RF CABLE ASSY SEMI-RIGID
2	E5092-61610	3	RF CABLE ASSY SEMI-RIGID
3	E5092-61611	2	RF CABLE ASSY SEMI-RIGID
4	E5092-61644	1	RF CABLE ASSY SEMI-RIGID

Top View (Miscellaneous Parts)

Figure 4-7 Top View (Miscellaneous Parts)

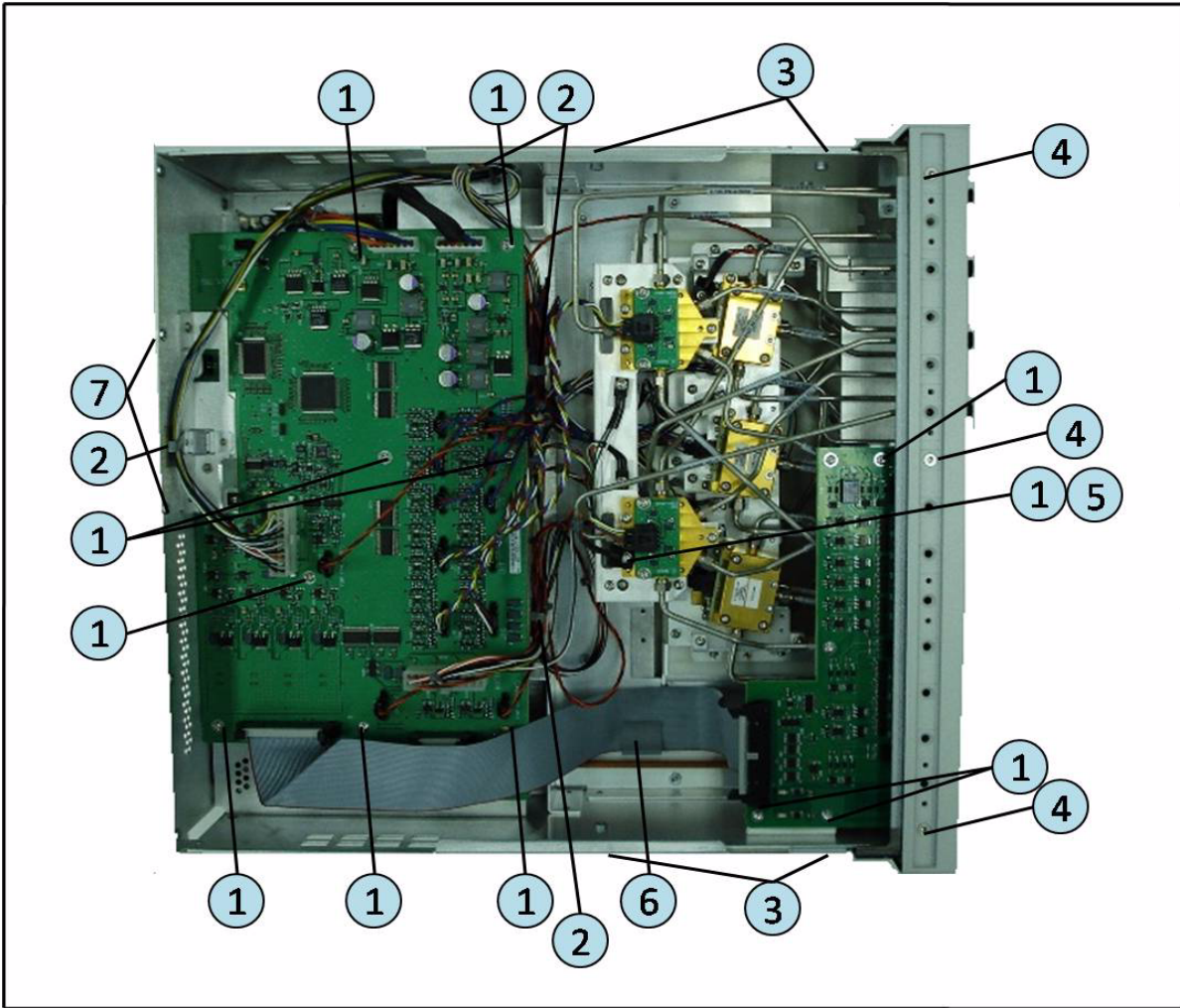

Table 4-7 Top View (Miscellaneous Parts)

Ref. Desig.	Agilent Part Number	Qty.	Description
1	0515-0372	14	SCREW MACH M3X0.5
2	1400-1391	4	CLAMP-CABLE STL
3	0515-1403	4	SCREW SPECIALTY M4X0.7
4	0515-1400	3	SCREW MACH M3X0.5
5	3050-0891	1	WASHER
6	1400-0611	1	CLAMP
7	0515-1946	2	SCREW MACH M3X0.5

Top View (Miscellaneous Parts) (Under Switch Control USB PCA)

Figure 4-8

Top View (Miscellaneous Parts) (Under Switch Control USB PCA)

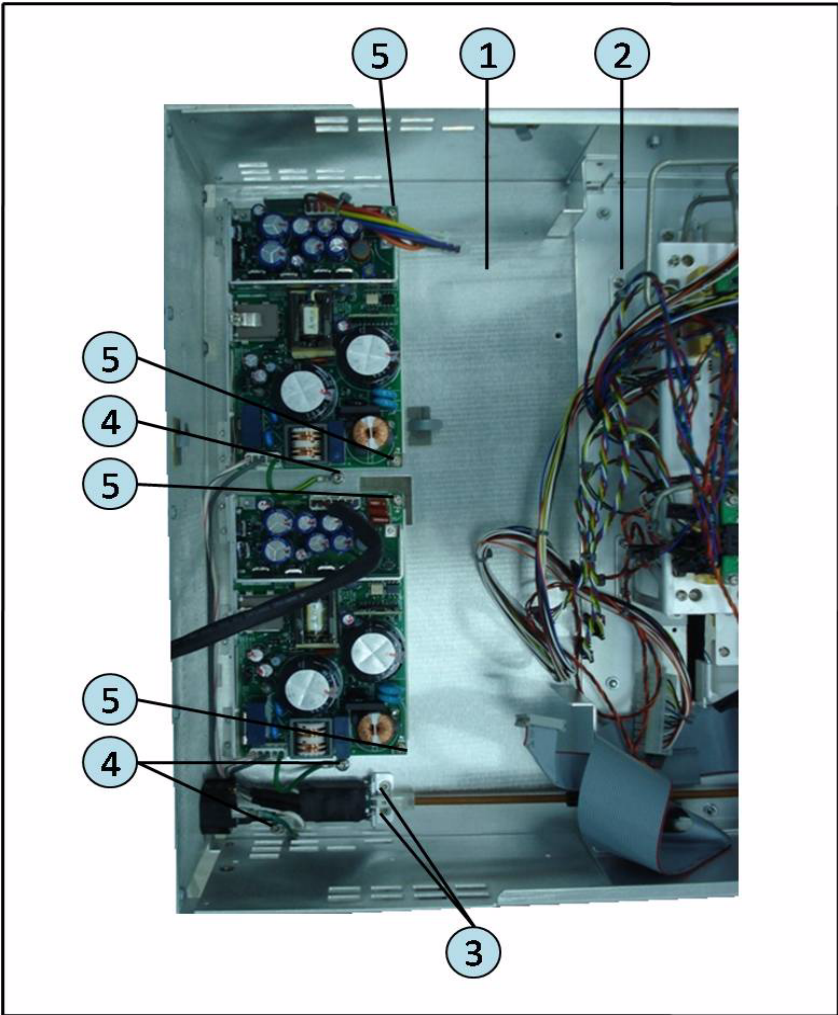

Table 4-8 Top View (Miscellaneous Parts) (Under Switch Control USB PCA)

Ref. Desig.	Agilent Part Number	Qty.	Description
1	E5092-00104	1	CHASSIS
2	E5092-00101	1	RF CHASSIS
3	0515-1946	4	SCREW MACH M3X0.5
4	0515-0433	2	SCREW MACH M4X0.7
5	0515-0372	3	SCREW MACH M3X0.5

4. Replaceable Parts

Bottom View (Cables)

Figure 4-9 Bottom View (Cables)

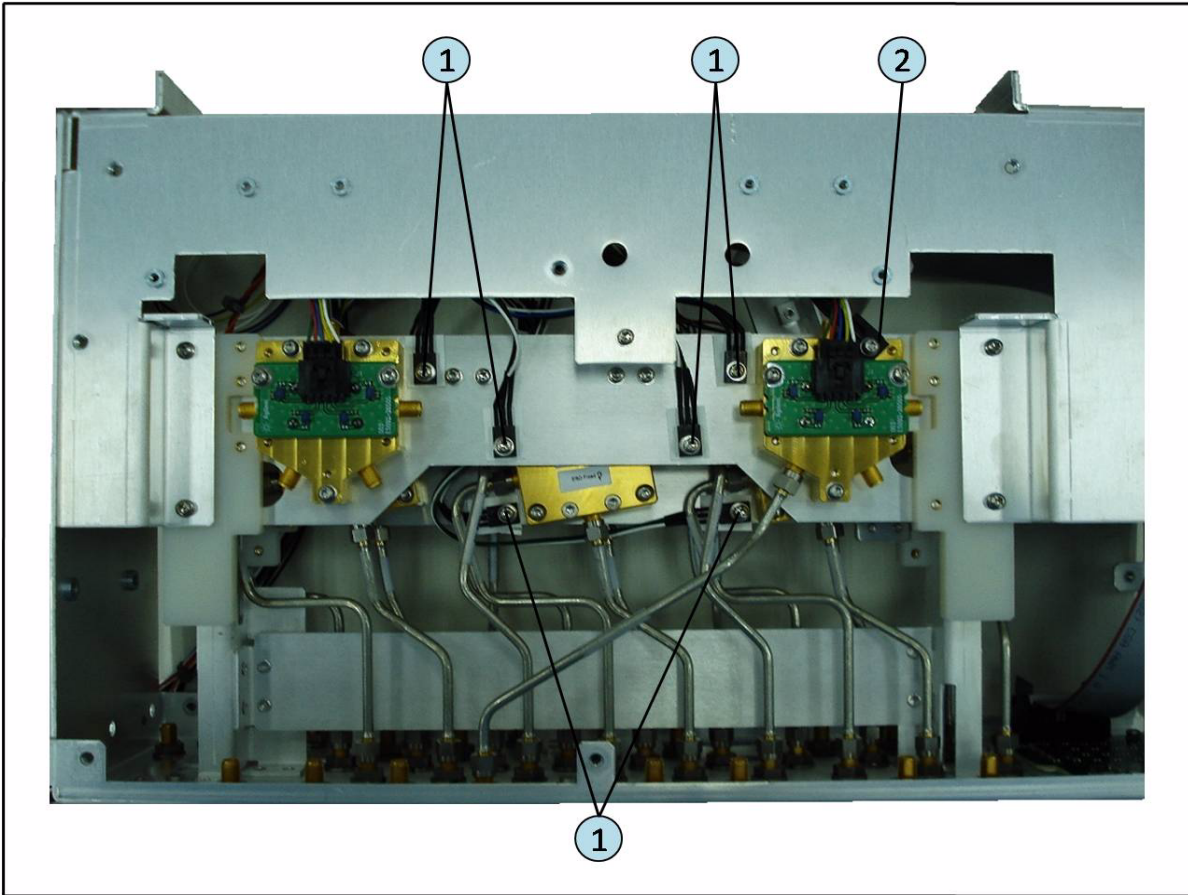

Table 4-9 Bottom View (Cables)

Ref. Desig.	Agilent Part Number	Qty.	Description
1	E5092-61646	1	WIRE ASSY
2	E5092-61667	1	WIRE ASSY

Bottom View (Semirigid Cables) (SP4T)

Figure 4-10 Bottom View (Semirigid Cables) (SP4T)

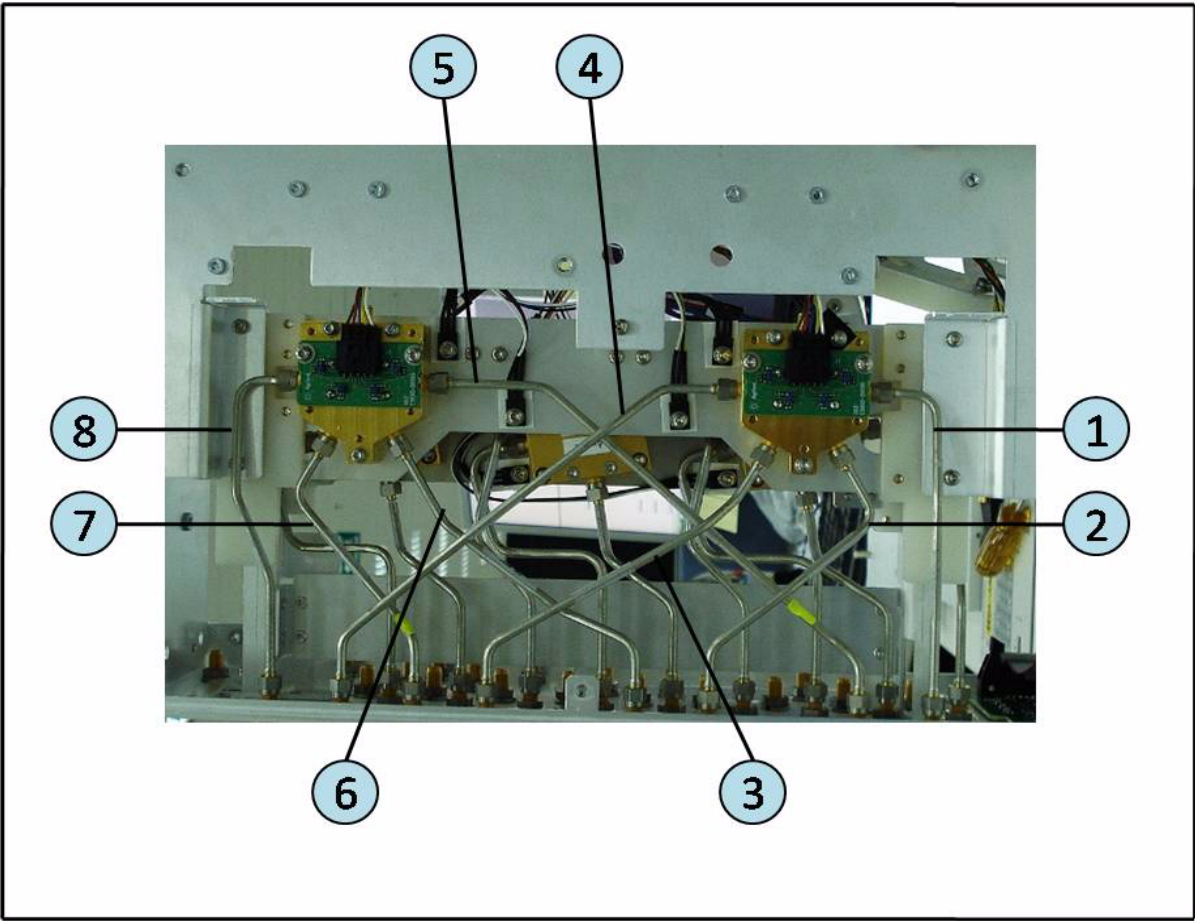

Table 4-10 Bottom View (Semirigid Cables) (SP4T)

Ref. Desig.	Agilent Part Number	Qty.	Description
1	E5092-61620	1	RF CABLE ASSY SEMI-RIGID
2	E5092-61619	1	RF CABLE ASSY SEMI-RIGID
3	E5092-61618	1	RF CABLE ASSY SEMI-RIGID
4	E5092-61617	1	RF CABLE ASSY SEMI-RIGID
5	E5092-61615	1	RF CABLE ASSY SEMI-RIGID
6	E5092-61614	1	RF CABLE ASSY SEMI-RIGID
7	E5092-61613	1	RF CABLE ASSY SEMI-RIGID
8	E5092-61622	1	RF CABLE ASSY SEMI-RIGID

4. Replaceable Parts

Bottom View (Semirigid Cables) (SPDT)

Figure 4-11 Bottom View (Semirigid Cables) (SPDT)

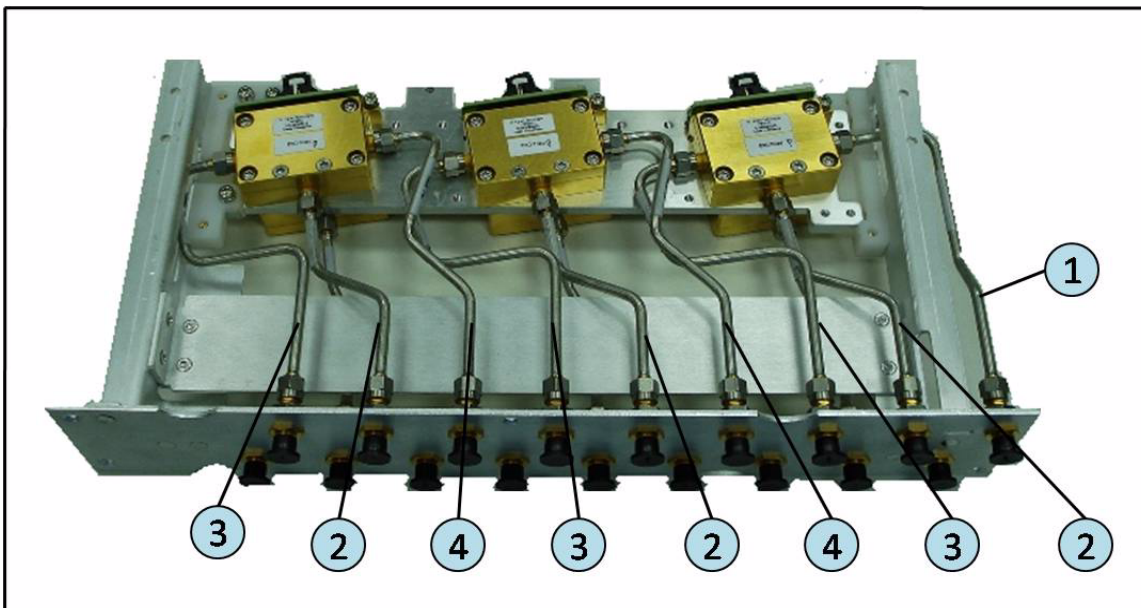

Table 4-11 Bottom View (Semirigid Cables) (SPDT)

Ref. Desig.	Agilent Part Number	Qty.	Description
1	E5092-61643	1	RF CABLE ASSY SEMI-RIGID
2	E5092-61641	3	RF CABLE ASSY SEMI-RIGID
3	E5092-61640	3	RF CABLE ASSY SEMI-RIGID
4	E5092-61642	2	RF CABLE ASSY SEMI-RIGID

Bottom View (Miscellaneous Parts)

Figure 4-12 Bottom View (Miscellaneous Parts)

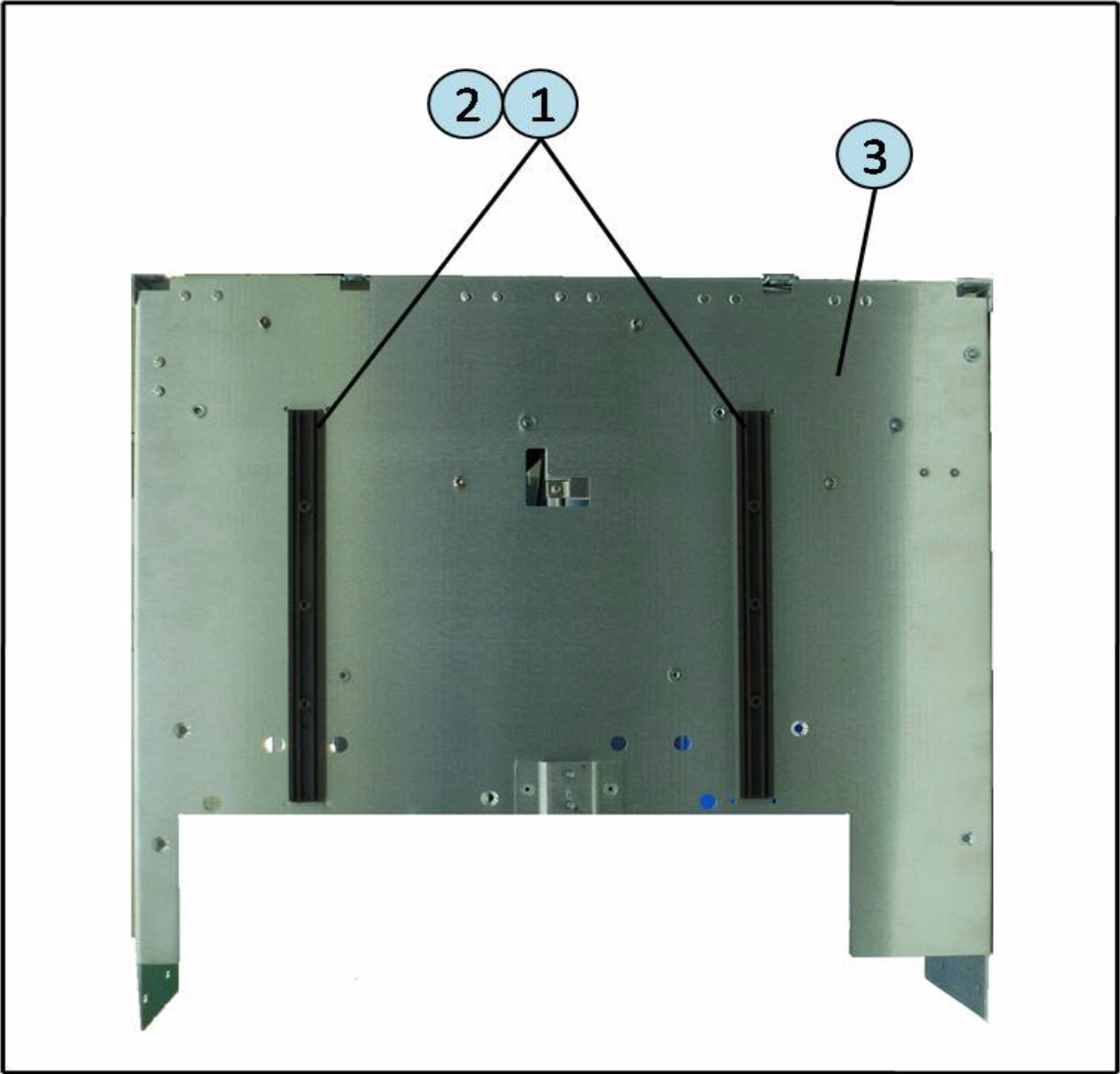

Table 4-12 Bottom View (Miscellaneous Parts)

Ref. Desig.	Agilent Part Number	Qty.	Description
1	5040-3347	2	PLATE
2	0460-0616	2	TAPE-INDL .5-IN-W .005-IN-T
3	E5092-00104	1	CHASSIS

4. Replaceable Parts

SP4T Switch Assembly (Top View)

Figure 4-13 SP4T Switch Assembly (Top View)

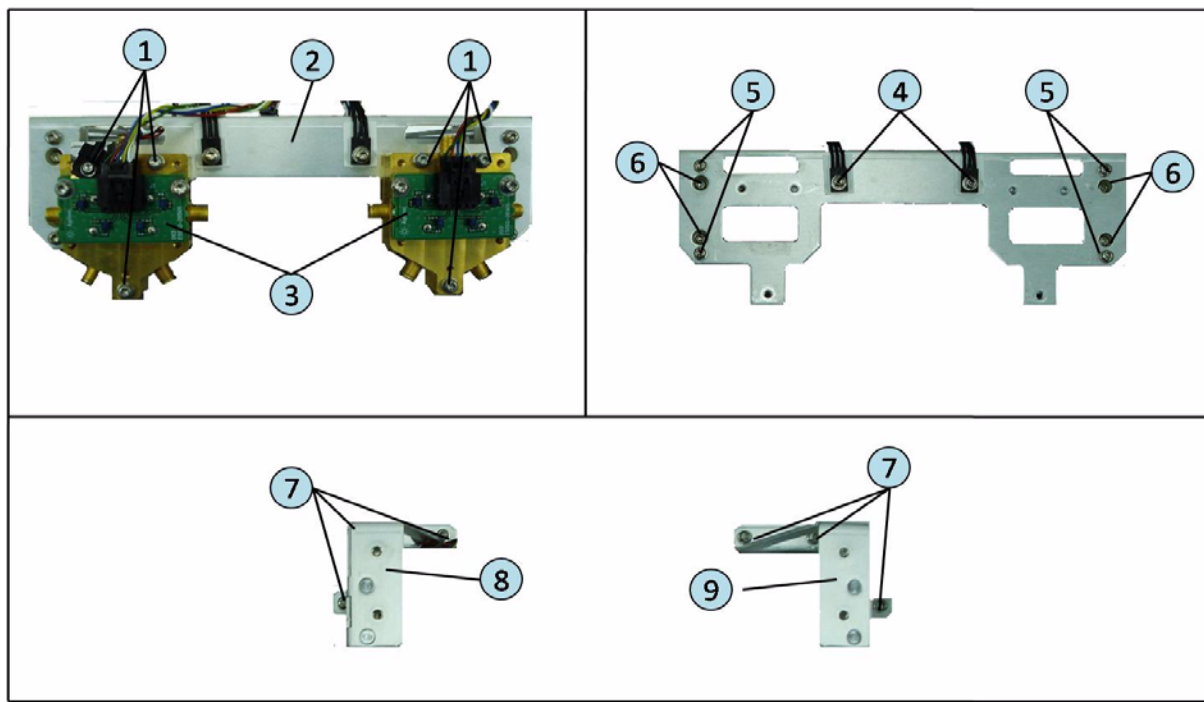
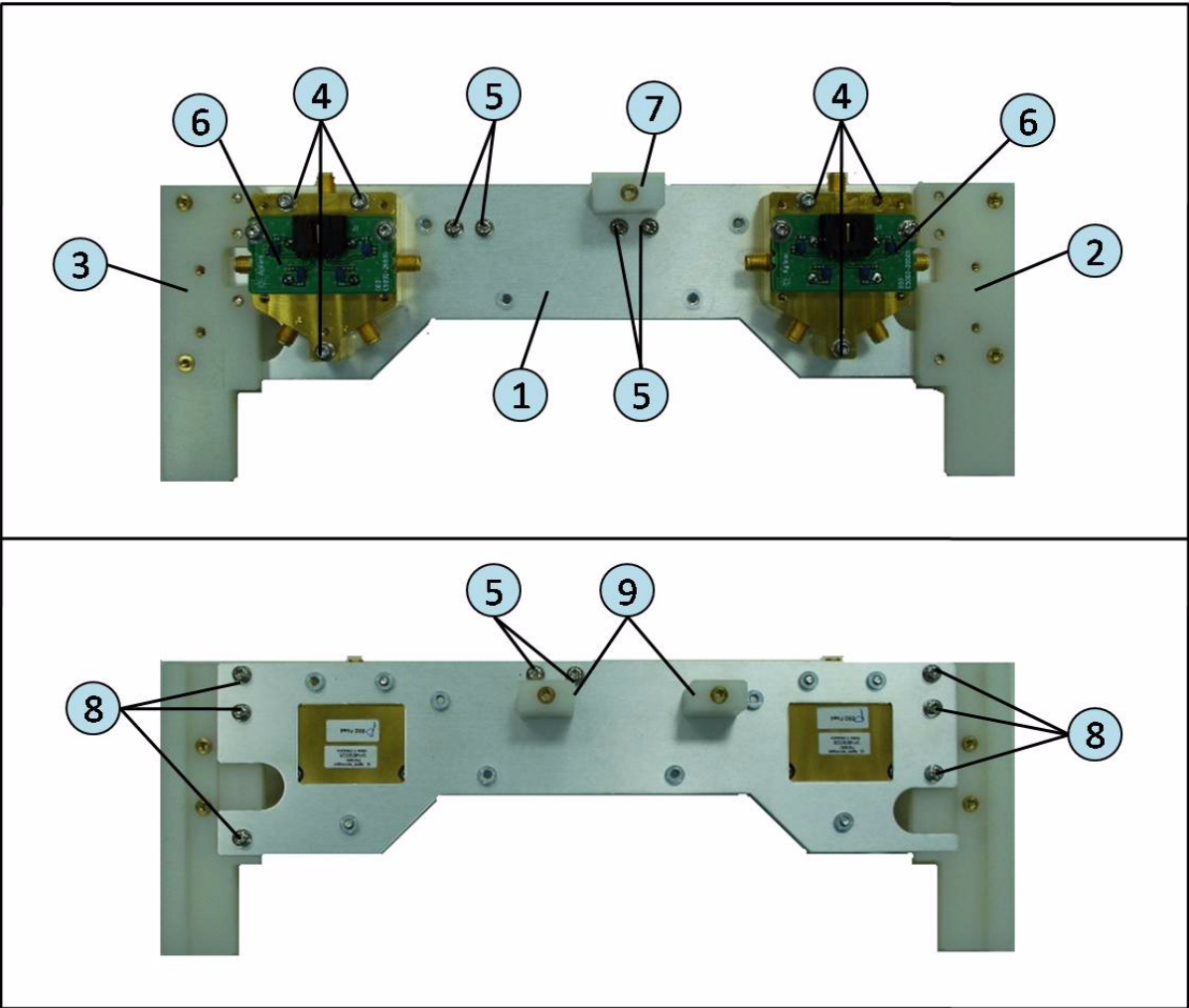

Table 4-13 SP4T Switch Assembly (Top View)

Ref. Desig.	Agilent Part Number	Qty.	Description
1	0515-2693	6	SCREW MACH M3X0.5
2	E5092-01217	1	BRACKET3
3	E5092-66505	2	SP4T SW BIAS PIN ADAPTER PCA
4	E5092-61645	2	WIRE ASSY
	0515-0372	2	SCREW MACH M3X0.5
	3050-0891	4	WASHER
5	0515-0372	4	SCREW MACH M3X0.5
6	0515-0375	4	SCREW MACH M3X0.5
7	0515-0372	6	SCREW MACH M3X0.5
8	E5092-01218	1	SIDE RIB1
9	E5092-01219	1	SIDE RIB2

SP4T Switch Assembly (Bottom View)

Figure 4-14 SP4T Switch Assembly (Bottom View)



4. Replaceable Parts

Replaceable Parts
Replaceable Parts List for E5092A-020

Table 4-14 **SP4T Switch Assembly (Bottom View)**

Ref. Desig.	Agilent Part Number	Qty.	Description
1	E5092-01216	1	BRACKET2
2	E5092-25003	1	SIDE INSULATOR1
3	E5092-25004	1	SIDE INSULATOR2
4	0515-2693	6	SCREW MACH M3X0.5
5	0515-0372	1	HT-SK T092
6	E5092-66505	2	SP4T SW BIAS PIN ADAPTER PCA
7	E5092-25005	1	SPACER1
8	0515-0372	6	SCREW MACH M3X0.5
9	E5092-25006	2	SPACER2

SPDT Switch Assembly (Top View)

Figure 4-15 SPDT Switch Assembly (Top View)

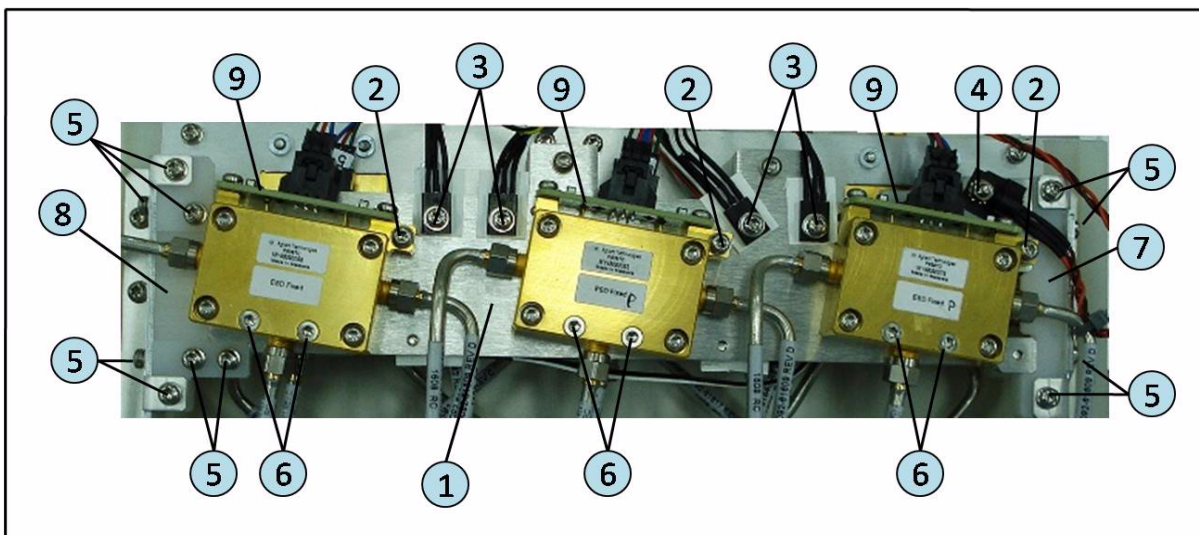

Table 4-15 SPDT Switch Assembly (Top View)

Ref. Desig.	Agilent Part Number	Qty.	Description
1	E5092-20000	1	PLATE
2	0515-0665	3	SCREW MACH M3X0.5
3	0515-0372	4	SCREW MACH M3X0.5
	3050-0891	4	WASHER
4	0535-0031	1	NUT-HEX W/LOCK WASHER M3X0.5
5	0515-0372	11	SCREW MACH M3X0.5
6	0515-2078	6	SCREW MACH FLT-HD M3X0.5
7	E5092-25002	1	INSULATOR2
8	E5092-25001	1	INSULATOR1
9	E5092-66504	3	SPDT SW BIAS PIN ADAPTER PCA

SPDT Switch Assembly (Bottom View)

Figure 4-16 SPDT Switch Assembly (Bottom View)

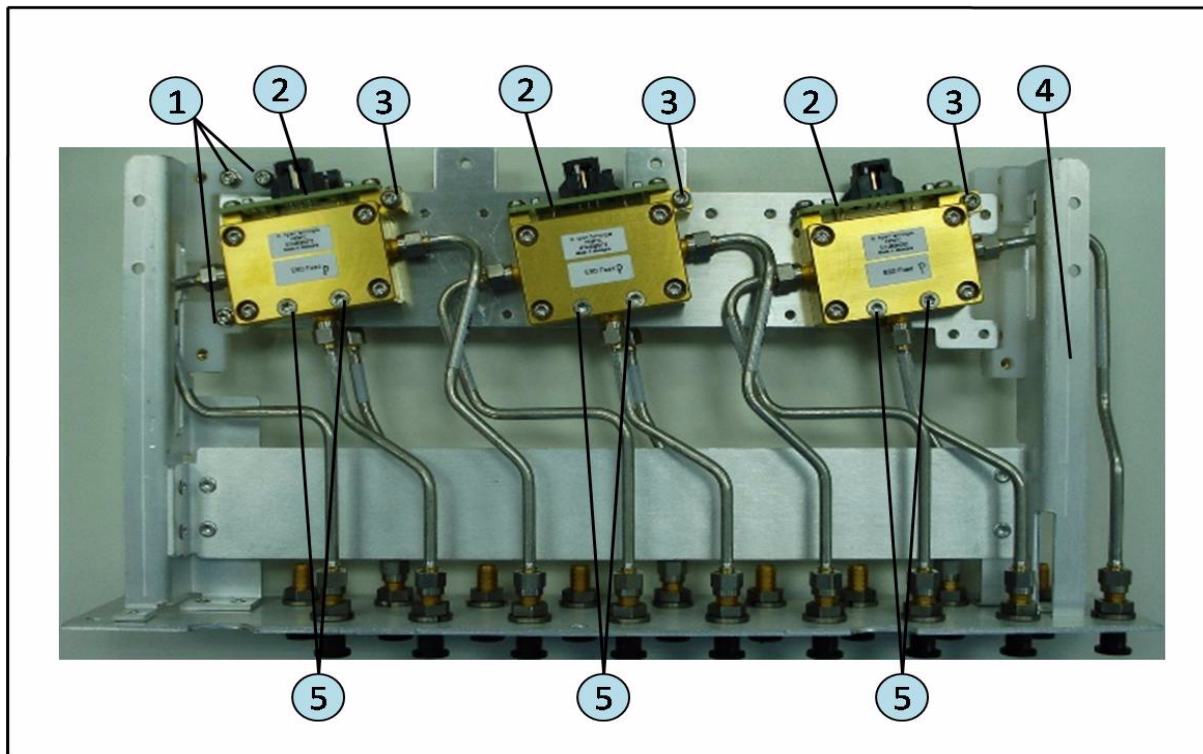

Table 4-16 SPDT Switch Assembly (Bottom View)

Ref. Desig.	Agilent Part Number	Qty.	Description
1	0515-0372	3	SCREW MACH M3X0.5
2	E5092-66504	3	SPDT SW BIAS PIN ADAPTER PCA
3	0515-0665	3	SCREW MACH M3X0.5
4	E5092-00105	1	DRAWER ASSEMBLY
5	0515-2078	6	SCREW MACH FLT-HD M3X0.5

Front Panel

Figure 4-17 Front Panel

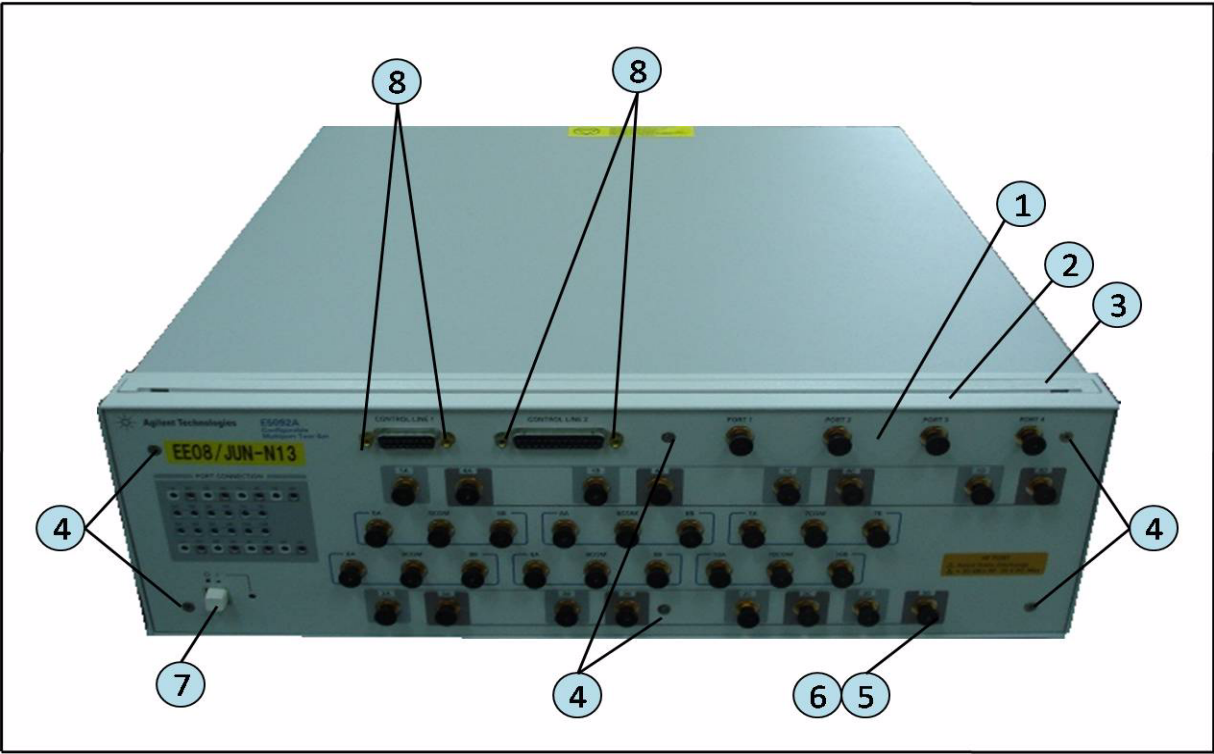

Table 4-17 Front Panel

Ref. Desig.	Agilent Part Number	Qty.	Description
1	E5092-00204	1	FRONT SHEET
2	5022-1188	1	FRONT FRAME
3	5041-9176	1	TRIM STRIP
4	0515-1946	6	SCREW MACH M3X0.5
5	1401-0245	38	PROTECTIVE CAP
6	1250-1251	38	ADAPTER - COAXIAL
7	5041-0564	1	KEY
8	1251-7812	4	JACKSCREW CONNECTOR

4. Replaceable Parts

Rear View

Figure 4-18 Rear View

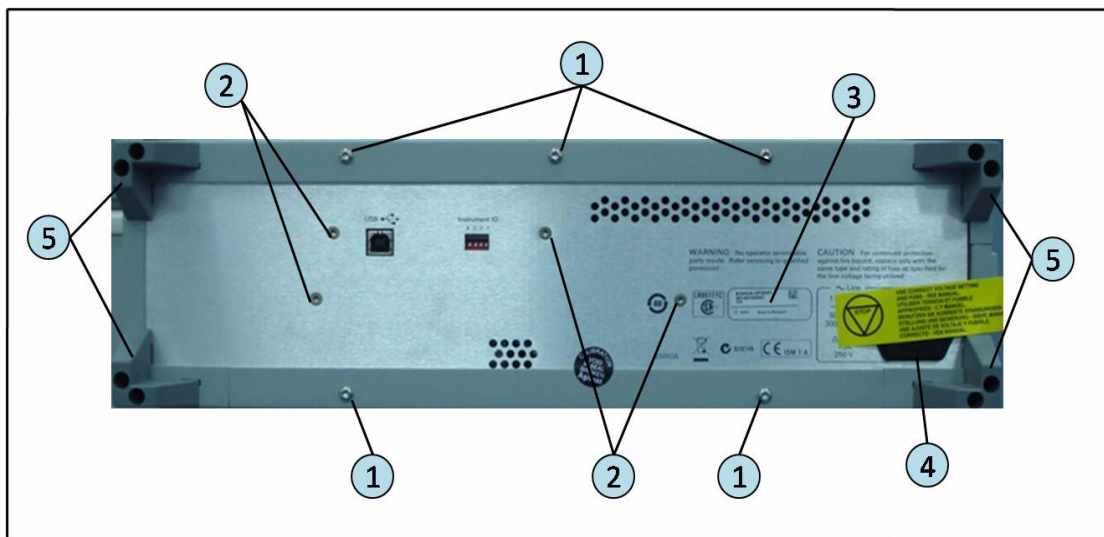

Table 4-18 Rear View

Ref. Desig.	Agilent Part Number	Qty.	Description
1	0515-1402	5	SCREW MACH M3.5X0.6
2	0515-1946	4	SCREW MACH M3X0.5
3	9320-6627	1	LABEL
4	2110-1017	1	FUSE
5	E5100-40002	4	STANDOFF

Side View

Figure 4-19

Side View

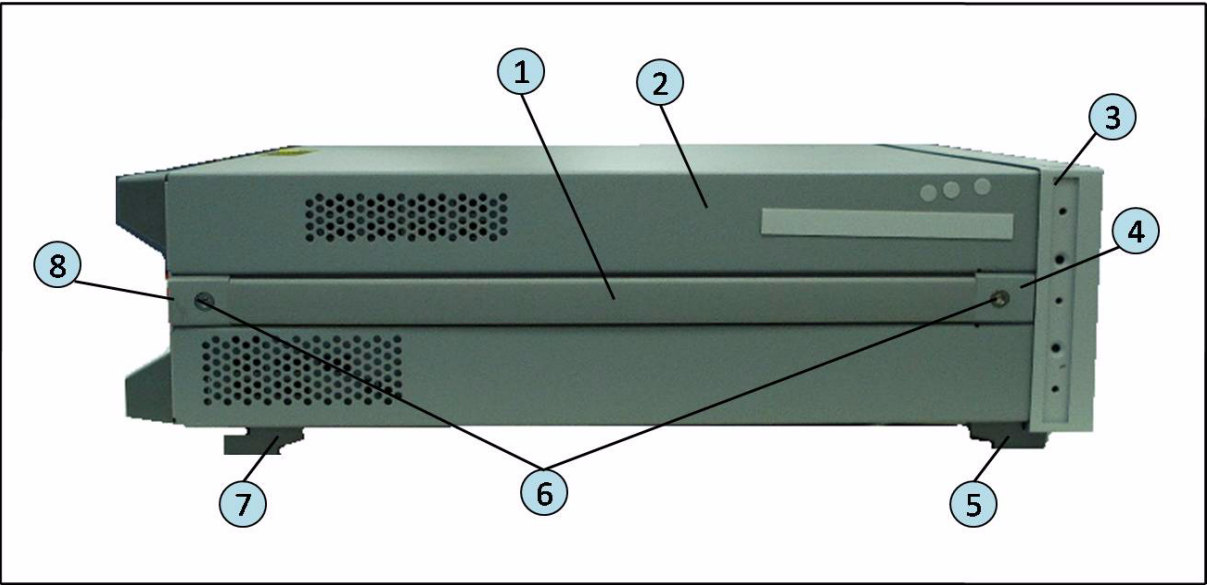

Table 4-19

Side View

Ref. Desig.	Agilent Part Number	Qty.	Description
1	08720-00081	1	STRAP HANDLE ASSY
2	E5092-60002	1	COVER
3	5022-1188	1	FRONT FRAME
4	5041-9186	1	CAP - STRAP HANDLE RETAINER - FRONT
5	5041-9167	2	FOOT
	1460-1345	2	TILT STAND
	5021-2840	2	KEY LOCK
6	0515-1384	2	SCREW MACH M5X0.8
	5021-2840	2	KEY LOCK
7	5041-9167	2	FOOT
	5021-2840	2	KEY LOCK
8	5041-9187	1	CAP - STRAP HANDLE RETAINER - REAR

4. Replaceable Parts

LED Assembly

Figure 4-20

LED Assembly

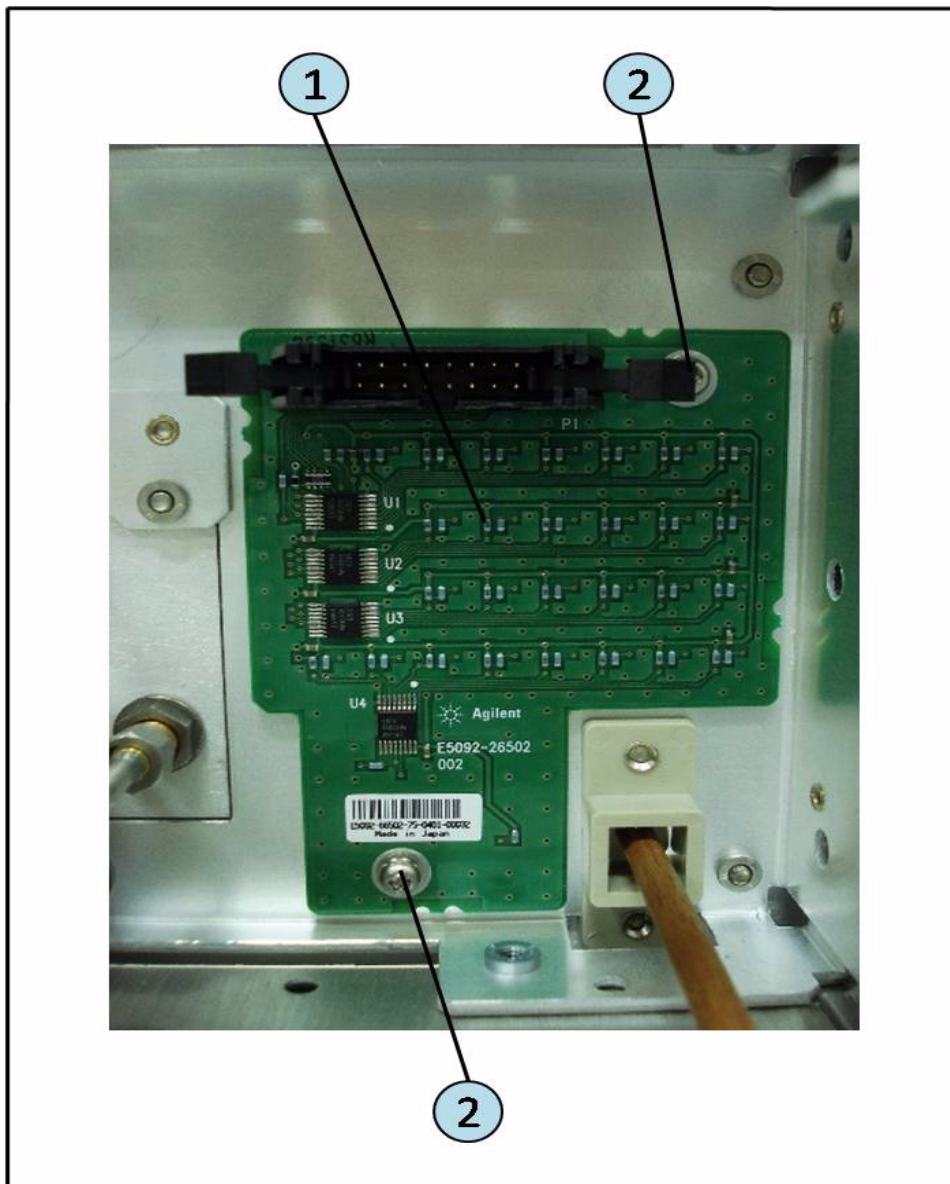

Table 4-20 LED Assembly

Ref. Desig.	Agilent Part Number	Qty.	Description
1	E5092-66602	1	SW INDICATOR LED PCA
2	0515-0430	2	SCREW MACH M3X0.5

Other Parts

Table 4-21 Other Parts

Agilent Part Number	Qty.	Description
E5092-900x0 ^{*1}	1	OPERATION MANUAL
E5092-901x0 ^{*1}	1	SERVICE MANUAL ^{*2}
E5092-905xx ^{*1}	1	CD-ROM 1.00 (DOCUMENTATION)
8120-4782	4	N-type cable
8121-1695	1	USB Cable

*1. The number indicated by “x” in the part number of each manual and CD-ROM, 0 for the first edition, is incremented by 1 each time a revision is made. The latest edition comes with the product.
*2. Opt. 0BW only

Replaceable Parts
Replaceable Parts List for E5092A-020

5 Replacement Procedure

This chapter provides procedure for removing and replacing the major assemblies in the E5092A.

Replacing an Assembly

The following steps show the sequence to replace an assembly in a E5092A.

1. Identify the faulty group. Refer to Chapter 3 , “Troubleshooting,”.
2. Order a replacement assembly. Refer to Chapter 4 , “Replaceable Parts,”.
3. Replace the faulty assembly and determine what verification is necessary. Refer to this chapter and Chapter 6 , “Post-Repair Procedures,”.
4. Perform the necessary performance tests. Refer to Chapter 2, “Performance Tests.”

WARNING These servicing instructions are for use by qualified personnel only. To avoid electrical shock, do not perform any servicing unless you are qualified to do so.

WARNING The opening of covers or removal of parts is likely to expose dangerous voltages. Disconnect the instrument from its power supply.

CAUTION Many of the assemblies in this instrument are very susceptible to damage from ESD(electrostatic discharge). Perform the following procedures only at a static-safe workstation and wear a grounding strap.

Required Tools

The following tools are required for repair of E5092A-020.

Table 5-1 Required Tools for E5092A-020

Assembly	TORX Screwdriver				Box wrench	Open wrench
	T 10	T 15	T 20	T 25	5.5mm	5/8 in.
Outer Cover	√	√	√			
Front chassis	√	√	√			
Front Frame	√	√	√			
A1 Switch Control Board	√	√	√			
Power Supply	√	√	√			
Power Switch	√	√	√			
Main Board	√	√	√		√	
SP4T Switch	√	√	√		√	√
SP4T Raptor Holder	√	√	√		√	√
SPDT Switch Drawer	√	√	√		√	√
SPDT Switch	√	√	√		√	√
Switch Indicator LED	√	√	√		√	

Replacement Procedure for E5092A-020

Outer Cover Removal

Tools Required

- TORX screwdriver, T10, T15, and T20

Procedure

Refer to Figure 5-1 for this procedure.

- Step 1.** Disconnect the power cable from the E5092A.
- Step 2.** Remove the two TORX T20 screws (item 1) fastening the side strap handles.
- Step 3.** Remove the four TORX T15 screws (item 2) fastening the four rear foot.
- Step 4.** Remove the five TORX T15 screws (item 3) fastening the cover from the rear side.
- Step 5.** Remove the four bottom feet (item 4).
- Step 6.** Remove the two TORX T10 screws (item 5) fastening the cover from the bottom.
- Step 7.** Slide the outer cover and remove it carefully.

Figure 5-1 Outer Cover Removal

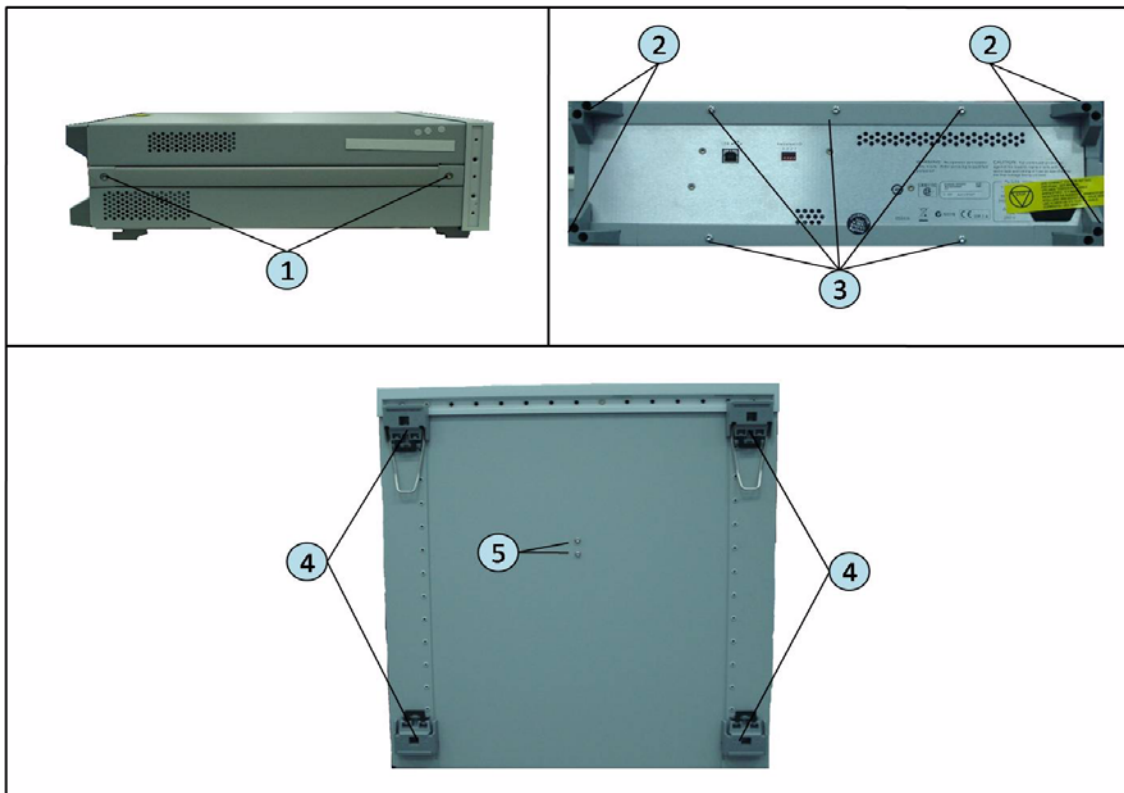

Front Chassis Detachment

Tools required

- TORX screwdriver, T10, T15 and T20

Procedure

Refer to Figure 5-2 for this procedure.

- Step 1.** Remove the outer cover as described in “Outer Cover Removal” on page 178.
- Step 2.** Disconnect the connectors (item 1, 2, 3 and 6) from the A1 Switch control board.
- Step 3.** Disconnect the flat cable connectors (item 4 and 5) from the A1 board.
- Step 4.** Remove the six TORX T15 screws (item 7) fastening the side panel.
- Step 5.** Remove the five TORX T10 screws (item 8) fastening the bottom chassis.
- Step 6.** Slide the front chassis forward to detach from the back chassis.

Figure 5-2 Front chassis Detachment

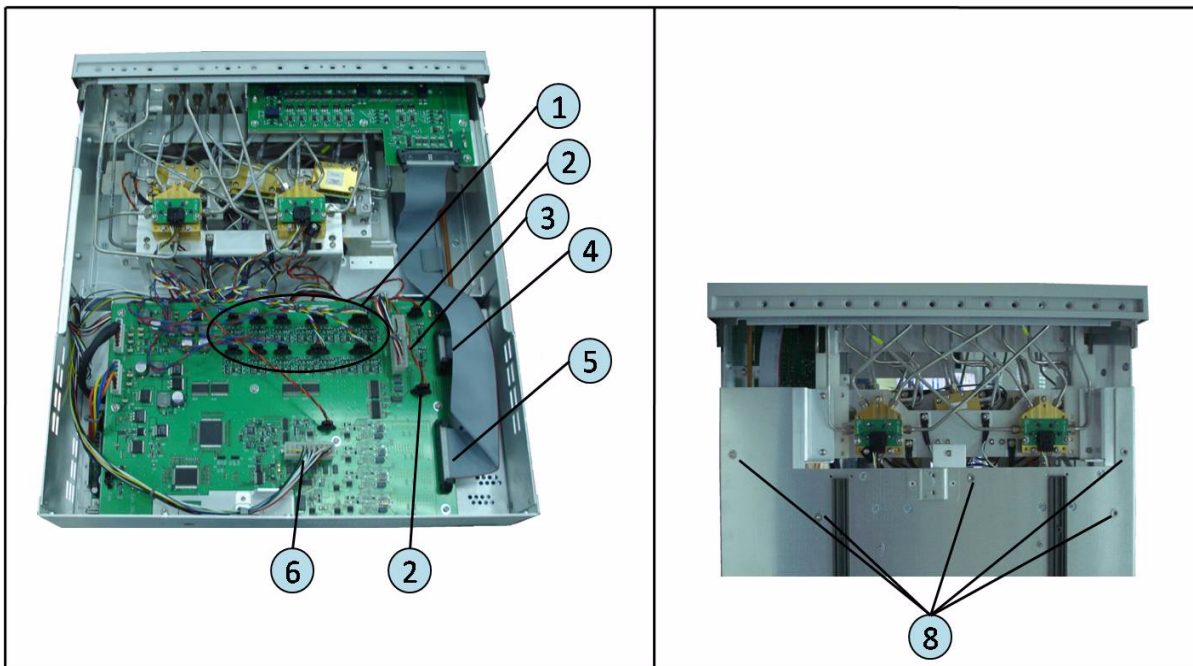

Front Frame Removal

Tools required

- TORX screwdriver, T10, T15 and T20

Procedure

Refer to Figure 5-3 for this procedure.

- Step 1.** Remove the outer cover as described in “Outer Cover Removal” on page 178.
- Step 2.** Remove the front chassis as described in “Front Chassis Detachment” on page 179.
- Step 3.** Remove the top trim from the front chassis (item 1).
- Step 4.** Remove the three TORX T15 screws (item 2) fastening the top frame.
- Step 5.** Remove the three TORX T15 screws (item 8) fastening the bottom frame.
- Step 6.** Slide the front frame and remove from the front chassis.

Figure 5-3 Front Frame Removal

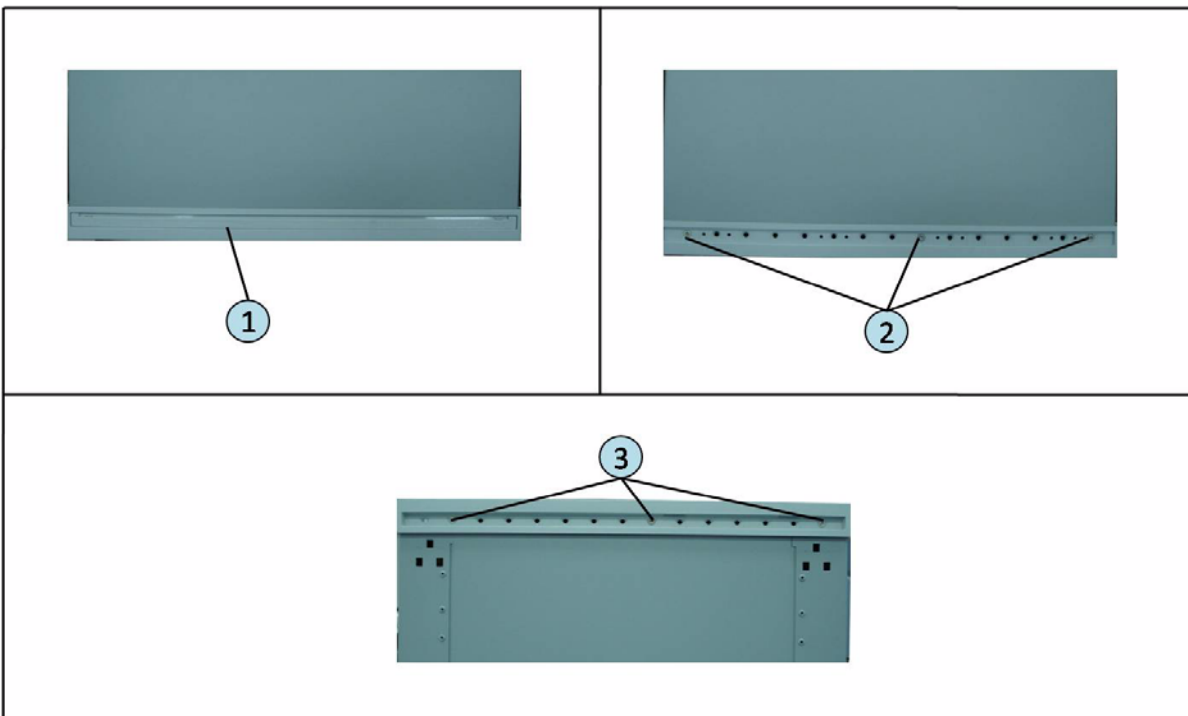

A1 Switch Control Board Removal

Tools Required

- TORX screwdriver, T10, T15 and T20.

Procedure

Refer to Figure 5-4 for this procedure.

Step 1. Remove the outer cover as described in “Outer Cover Removal” on page 178.

Step 2. Disconnect all the cables connected on the A1 Switch control board.

Step 3. Remove the two TORX T10 screws (item 1) from the rear panel.

Step 4. Remove the six TORX T10 screws (item 2) fastening the A1 board.

Step 5. Remove the A1 board from the chassis.

Figure 5-4 A1 Switch Control Board Removal

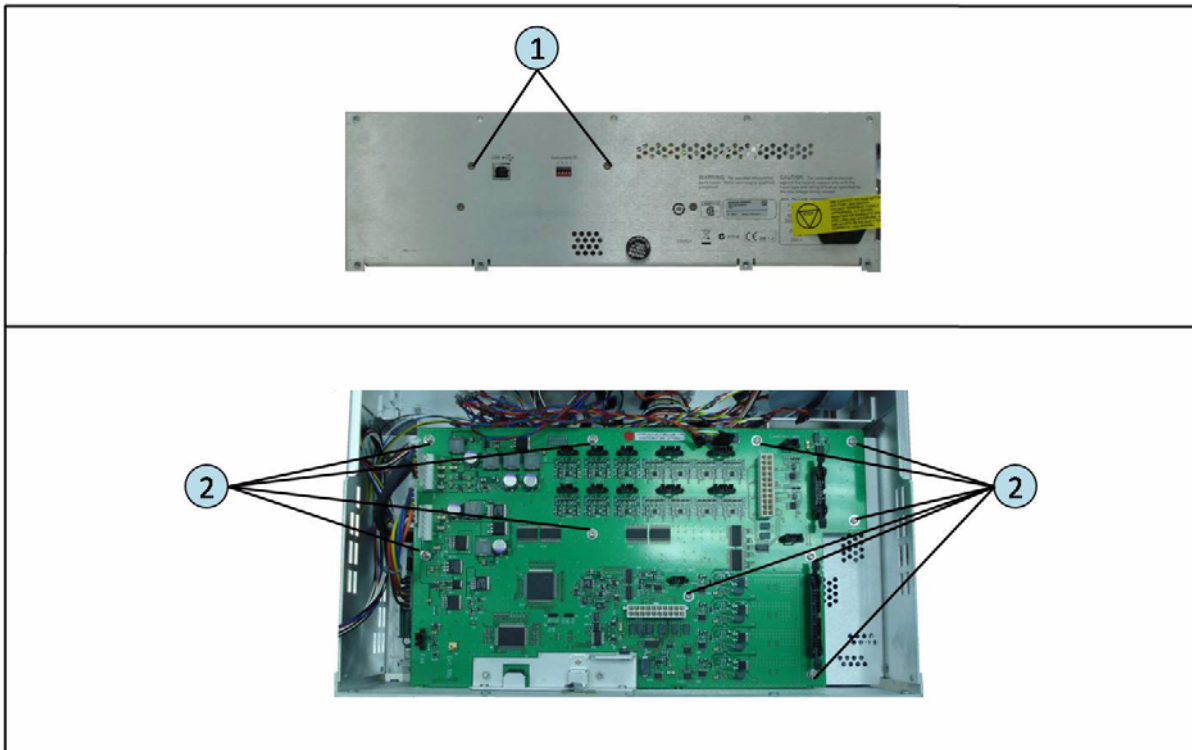

Power Supply Assembly Removal

Tools Required

- TORX screwdriver, T10, T15 and T20.

Procedure

Refer to Figure 5-5 for this procedure.

- Step 1.** Remove the outer cover as described in “Outer Cover Removal” on page 178.
- Step 2.** Remove the A1 switch control board as described in “A1 Switch Control Board Removal” on page 181.
- Step 3.** Disconnect the two power cable (item 1).
- Step 4.** Remove the four TORX T10 screw (item 2) from the bottom.
- Step 5.** Remove the power supply board from the chassis.

Figure 5-5 Power Supply Assembly Removal

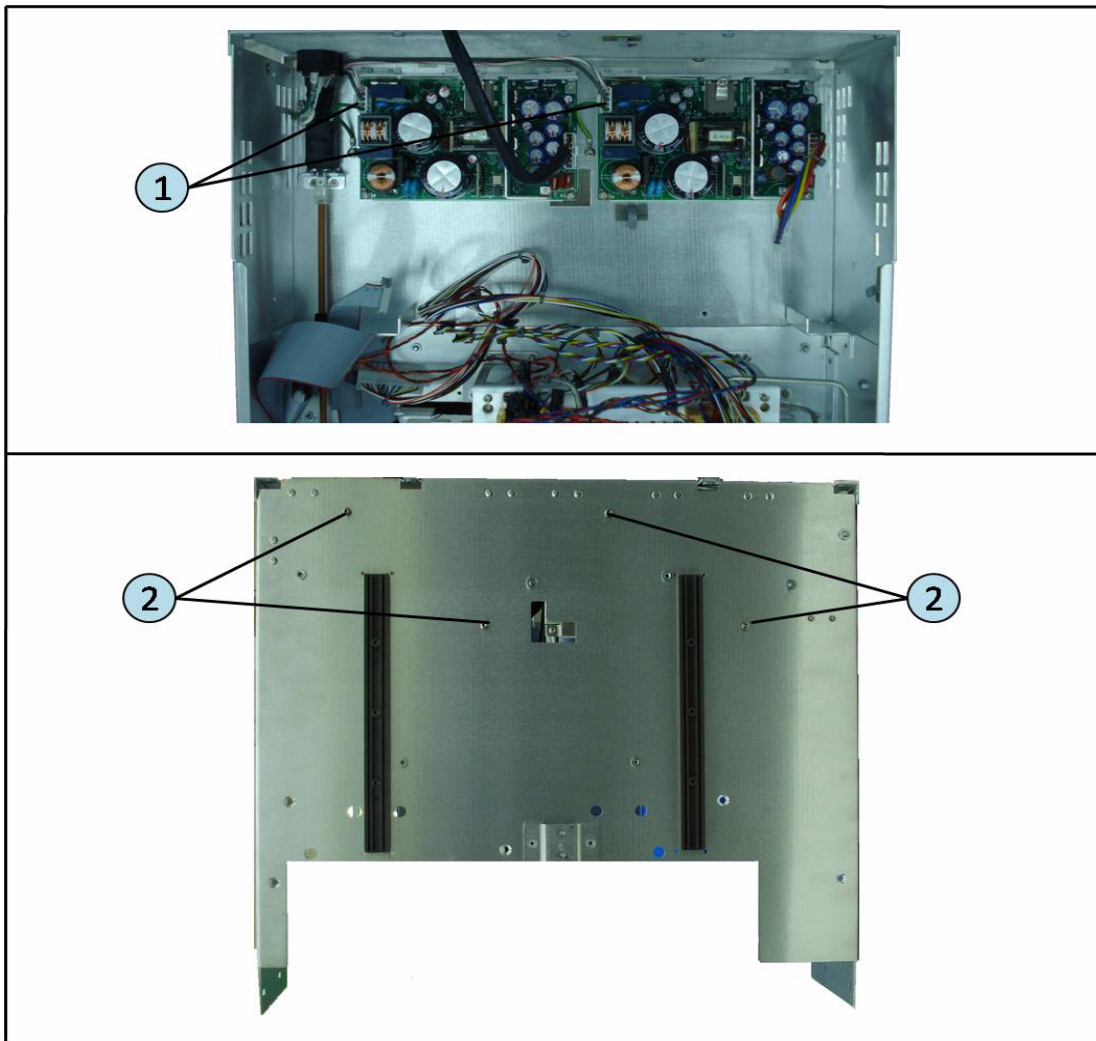

Power Switch Removal

Tools Required

- TORX screwdriver, T10, T15 and T20.

Procedure

Refer to Figure 5-6 for this procedure.

- Step 1.** Remove the outer cover as described in “Outer Cover Removal” on page 178.
- Step 2.** Remove the A1 switch control board as described in “A1 Switch Control Board Removal” on page 181.
- Step 3.** Disconnect the power cable (item 1).
- Step 4.** Remove the two TORX T20 screws (item 2) from the chassis.
- Step 5.** Pull out the three terminals (item 3) from the AC receptacle terminal.
- Step 6.** Disjoint the joint (item 4) from the power switch and the rod.
- Step 7.** Remove the two TORX T10 screws (item 5) from the chassis and remove the power switch.

Figure 5-6 Power Switch Assembly Removal

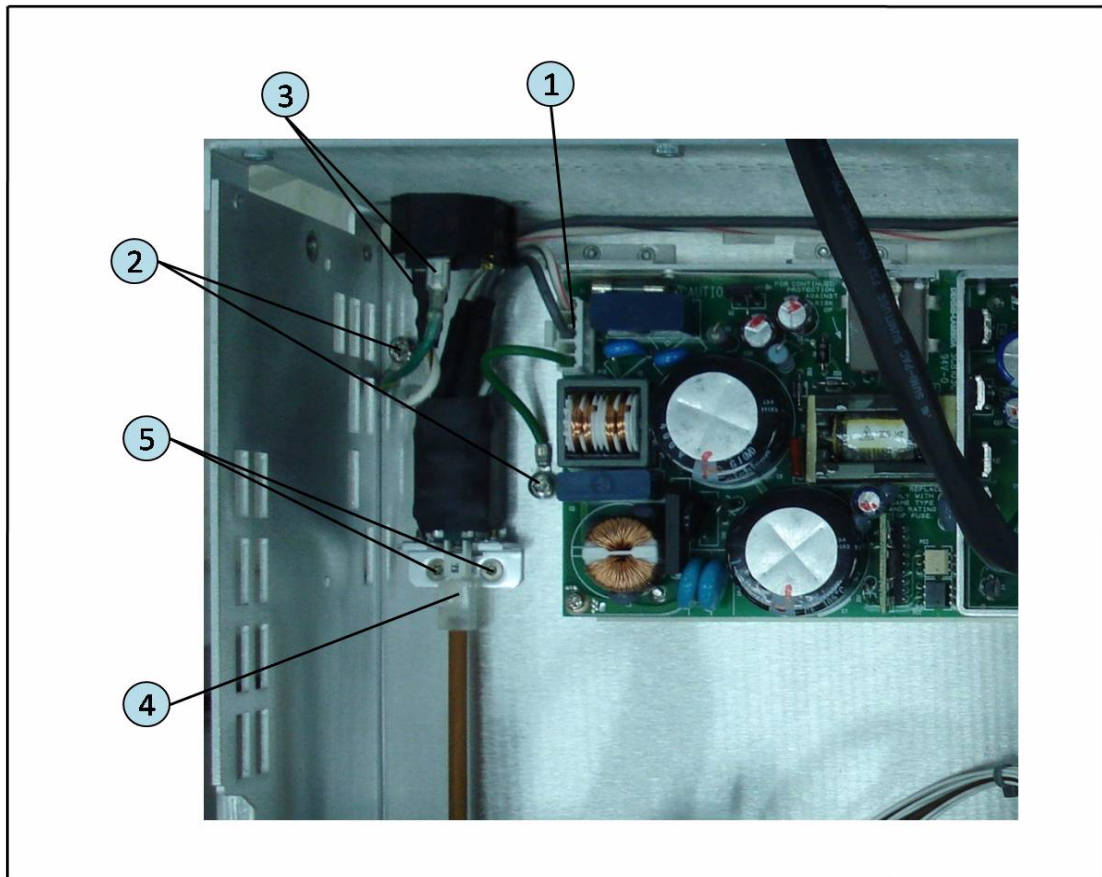

Main Board Removal

Tools Required

- Box wrench 5.5mm
- TORX screwdriver, T10, T15 and T20.

Procedure

Refer to Figure 5-7 for this procedure.

- Step 1.** Remove the outer cover as described in “Outer Cover Removal” on page 178.
- Step 2.** Detach the front chassis as described in “Front Chassis Detachment” on page 179.
- Step 3.** Remove the front frame as described in “Front Frame Removal” on page 180.
- Step 4.** Remove the three TORX T10 screws (item 1) from the assembly.
- Step 5.** Remove the four hex nut (item 2) from the assembly.
- Step 6.** Lift the main board from the assembly.

Figure 5-7 Main Board Removal

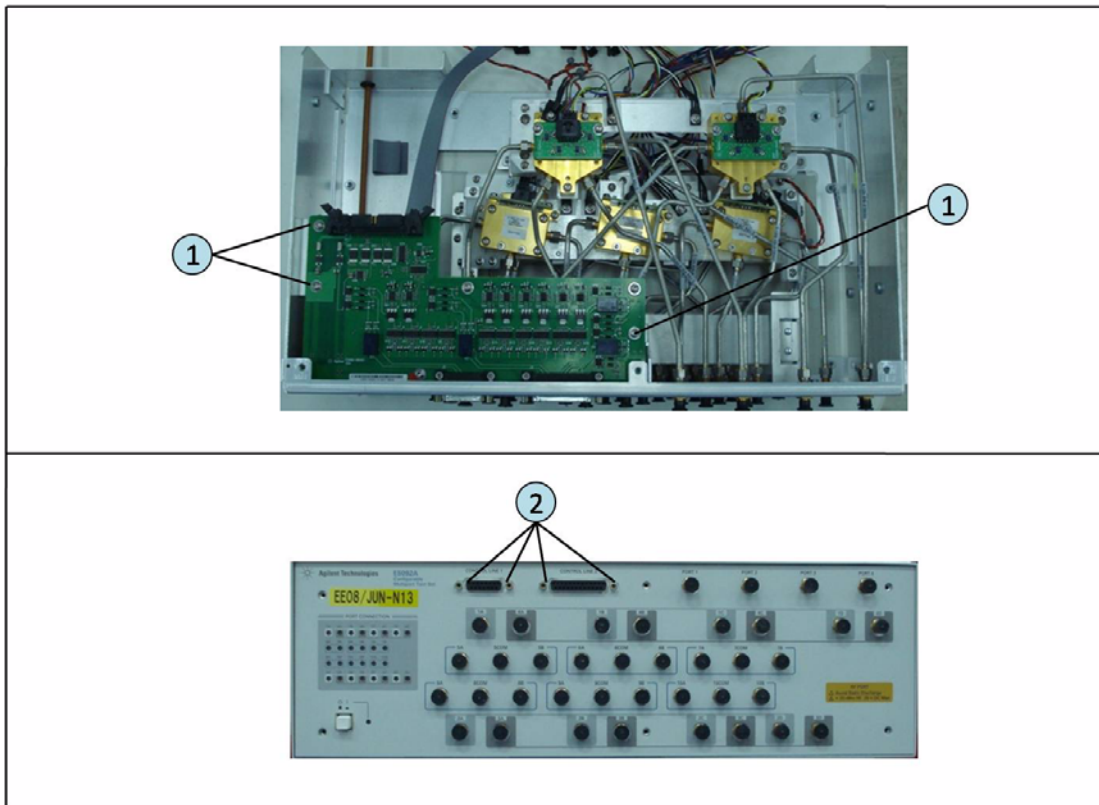

SP4T Switch Assembly Removal

Tools Required

- TORX screwdriver, T10, T15 and T20.
- Box wrench 5.5mm
- Torque wrench, 5/8 in.

Procedure

Refer to Figure 5-8 for this procedure.

- Step 1.** Remove the outer cover as described in “Outer Cover Removal” on page 178.
- Step 2.** Detach the front chassis as described in “Front Chassis Detachment” on page 179.
- Step 3.** Remove the front frame as described in “Front Frame Removal” on page 180.
- Step 4.** Remove the assembly board as described in “Main Board Removal” on page 184.
- Step 5.** Remove the TORX T10 screw (item 1) on the SP4T switch assembly.
- Step 6.** Remove the twelve semirigid cables (item 2) on the SP4T switch assembly.
- Step 7.** Remove the six TORX T10 screw (item 3) on the SP4T switch assembly and remove the top two SP4T switches.
- Step 8.** Remove the SP4T raptor holder assembly as described in “SP4T Raptor Holder Assembly Removal” on page 187.
- Step 9.** Turn the front chassis over and remove the eight semirigid cables (item 4) from the bottom SP4T switch assembly.
- Step 10.** Remove the six TORX T10 screw (item 5) on the SP4T switch assembly and remove the bottom two SP4T switches.

Figure 5-8 SP4T Switch Assembly Removal

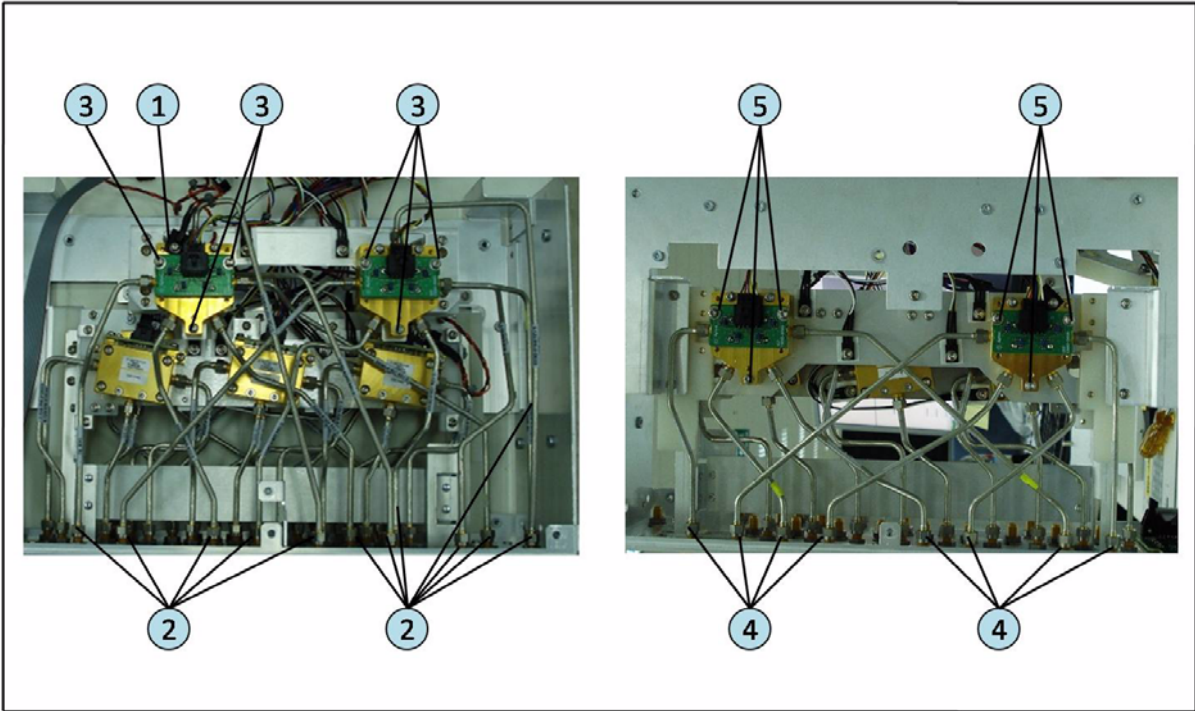

SP4T Raptor Holder Assembly Removal

Tools Required

- TORX screwdriver, T10, T15 and T20.
- Box wrench 5.5mm
- Torque wrench, 5/8 in.

Procedure

Refer to Figure 5-9 for this procedure.

- Step 1.** Remove the outer cover as described in “Outer Cover Removal” on page 178.
- Step 2.** Detach the front chassis as described in “Front Chassis Detachment” on page 179.
- Step 3.** Remove the front frame as described in “Front Frame Removal” on page 180.
- Step 4.** Remove the assembly board as described in “Main Board Removal” on page 184.
- Step 5.** Remove the SP4T switch assembly as described in “SP4T Switch Assembly Removal” on page 185.
- Step 6.** Remove the two TORX T10 screw (item 1) on the SP4T raptor holder assembly and remove the cables.
- Step 7.** Remove the four TORX T10 screw (item 2) holding the SP4T raptor holder assembly and lift the raptor holder assembly.
- Step 8.** Remove the semirigid cable (item 3) on the SPDT switch assembly.
- Step 9.** Remove the six TORX T10 screw (item 4) holding the SP4T raptor holder assembly and lift the raptor holder assembly.

Replacement Procedure
Replacement Procedure for E5092A-020

Figure 5-9 SP4T Raptor Holder Assembly Removal

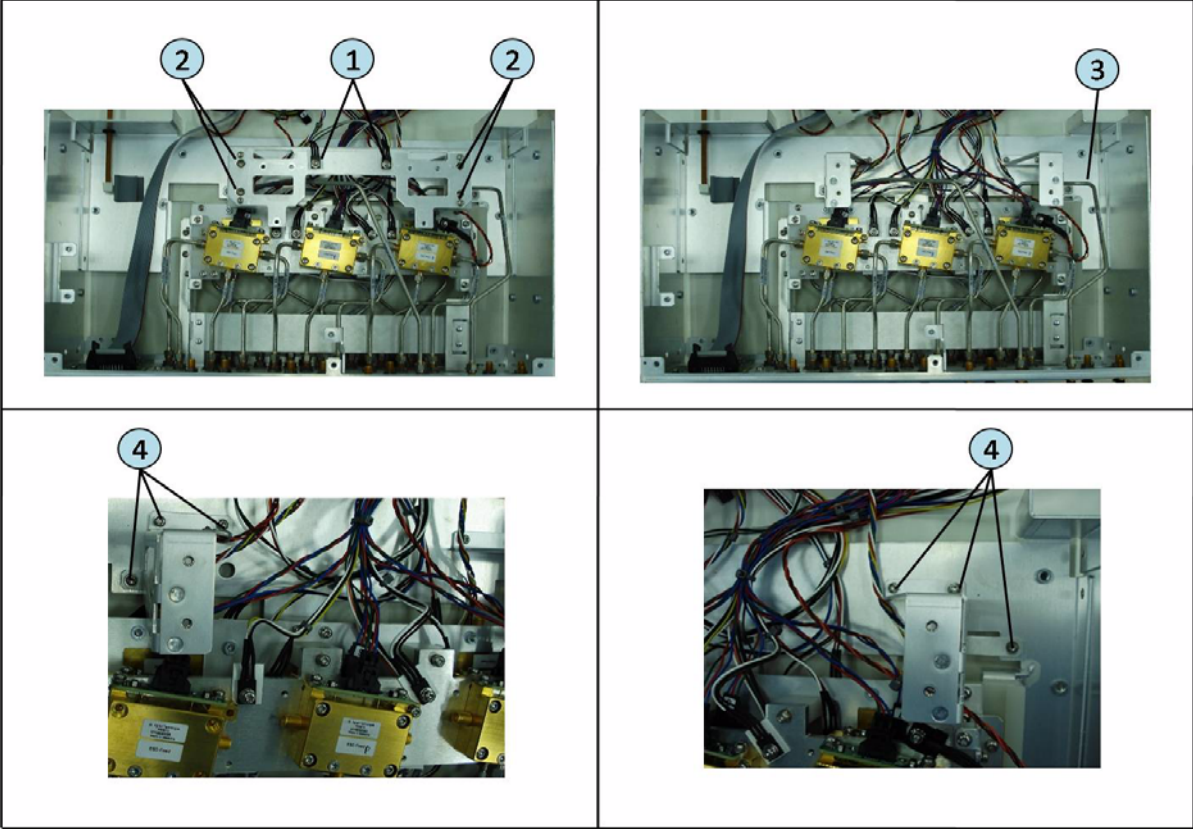

SPDT Switch Drawer Removal

Tools Required

- TORX screwdriver, T10, T15 and T20.
- Box wrench 5.5mm
- Torque wrench, 5/8 in.

Procedure

Refer to Figure 5-10 for this procedure.

- Step 1.** Remove the outer cover as described in “Outer Cover Removal” on page 178.
- Step 2.** Detach the front chassis as described in “Front Chassis Detachment” on page 179.
- Step 3.** Remove the front frame as described in “Front Frame Removal” on page 180.
- Step 4.** Remove the assembly board as described in “Main Board Removal” on page 184.
- Step 5.** Remove the SP4T switch assembly as described in “SP4T Switch Assembly Removal” on page 185.
- Step 6.** Remove the SP4T raptor holder assembly as described in “SP4T Raptor Holder Assembly Removal” on page 187.
- Step 7.** Disconnect the connectors (item 1) connected to the SPDT switches.
- Step 8.** Remove the four TORX T10 screws (item 2) connecting the four heaters and remove the wires.
- Step 9.** Unclamp the heater sensor (item 3) from the SPDT switch drawer assembly.
- Step 10.** Remove the six TORX T10 screw (item 4) securing the SPDT switch assembly.
- Step 11.** Remove the six TORX T10 screw (item 5) from the front panel and remove the front sheet.
- Step 12.** Remove the four TORX T10 screw (item 6) from the front chassis and slide out the SPDT switch drawer (item 7).

Replacement Procedure
Replacement Procedure for E5092A-020

Figure 5-10 SPDT Switch Drawer Removal

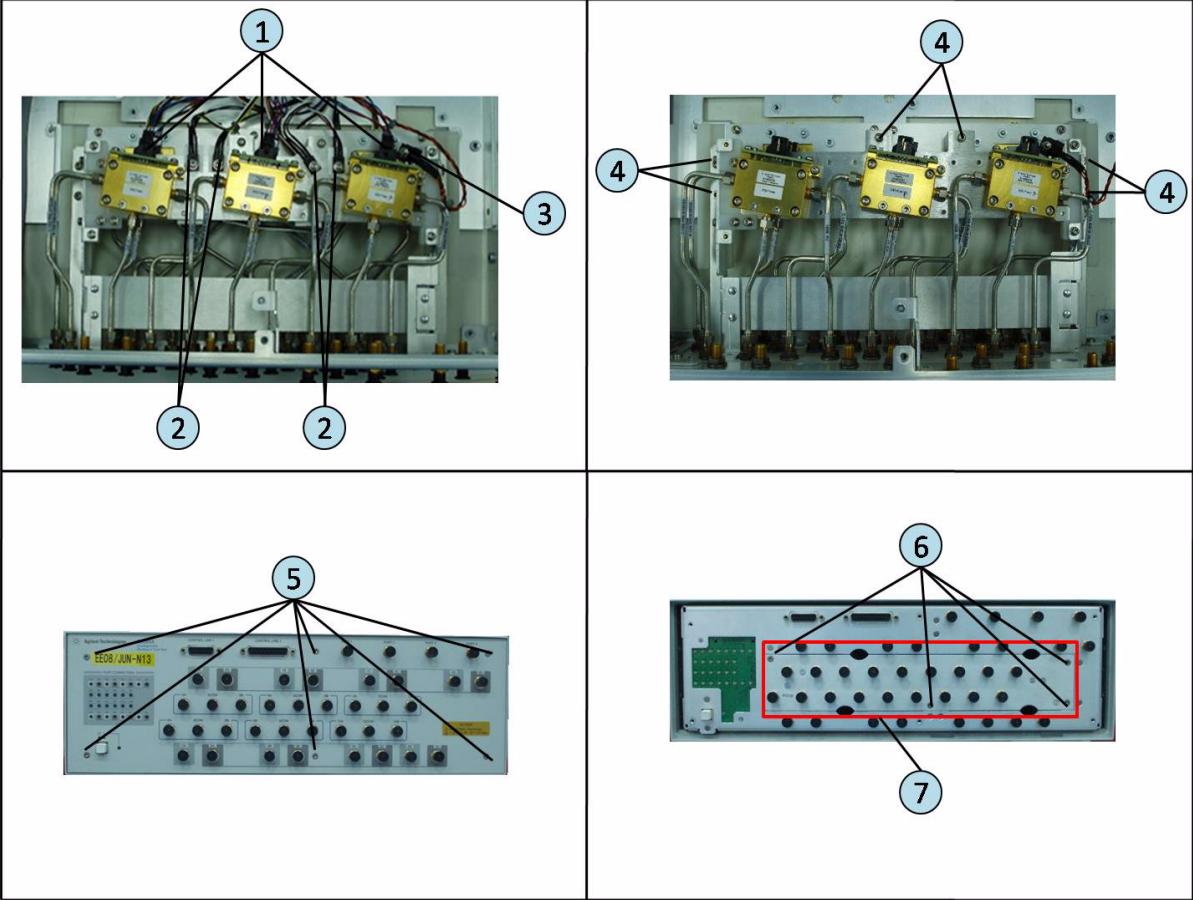

SPDT Switch Assembly Removal

Tools Required

- TORX screwdriver, T10, T15 and T20.
- Box wrench 5.5mm
- Torque wrench, 5/8 in.

Procedure

Refer to Figure 5-11 for this procedure.

- Step 1.** Remove the outer cover as described in “Outer Cover Removal” on page 178.
- Step 2.** Detach the front chassis as described in “Front Chassis Detachment” on page 179.
- Step 3.** Remove the front frame as described in “Front Frame Removal” on page 180.
- Step 4.** Remove the assembly board as described in “Main Board Removal” on page 184.
- Step 5.** Remove the SP4T switch assembly as described in “SP4T Switch Assembly Removal” on page 185.
- Step 6.** Remove the SP4T raptor holder assembly as described in “SP4T Raptor Holder Assembly Removal” on page 187.
- Step 7.** Remove the SPDT switch drawer as described in “SPDT Switch Drawer Removal” on page 189.
- Step 8.** Remove the six semirigid cables (item 1 followed by item 2) connecting the SPDT switch to the front panel.
- Step 9.** Remove the three TORX T10 screw (item 3) securing each SPDT switch.
- Step 10.** Remove the three semirigid cables (item 4) connecting the SPDT switch to the front panel.
- Step 11.** Repeat Step 8 to Step 10 for the three SPDT switches on the other side of the SPDT drawer assembly.

Figure 5-11 SPDT Switch Assembly Removal

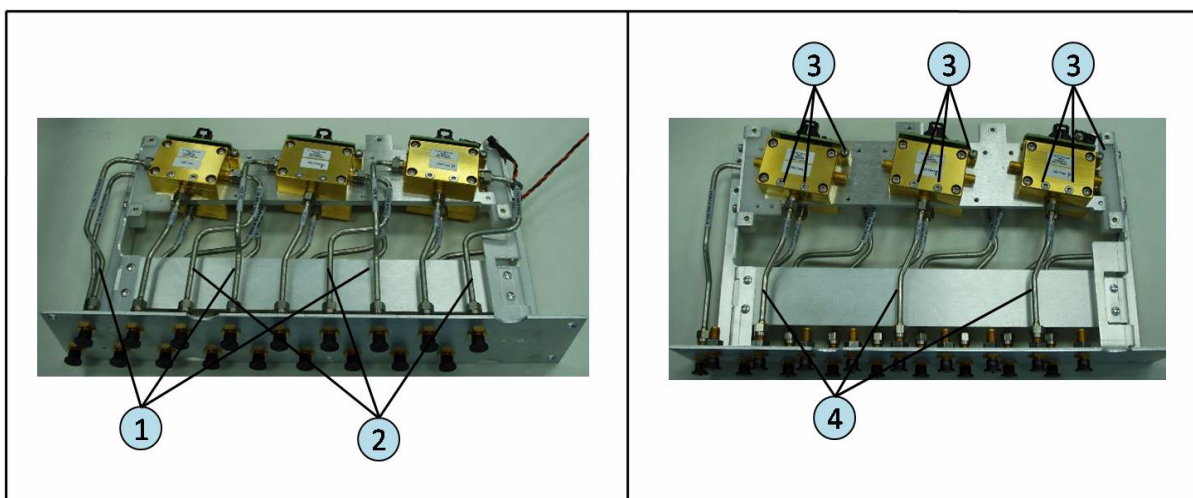

Switch Indicator LED PCA Removal

Tools Required

- Box wrench 5.5mm
- TORX screwdriver, T10, T15 and T20.

Procedure

Refer to Figure 5-12 for this procedure.

- Step 1.** Remove the outer cover as described in “Outer Cover Removal” on page 178.
- Step 2.** Detach the front chassis as described in “Front Chassis Detachment” on page 179.
- Step 3.** Remove the front frame as described in “Front Frame Removal” on page 180.
- Step 4.** Remove the main board as described in “Main Board Removal” on page 184.
- Step 5.** Disconnect the flat cable assembly (item 1) connected to the switch indicator LED PCA.
- Step 6.** Remove the two TORX T10 screws (item 2 and item 3) securing the switch indicator LED PCA to the front panel..
- Step 7.** Remove the switch indicator LED PCA from the assembly (item 4).

Figure 5-12

Switch Indicator LED PCA Removal

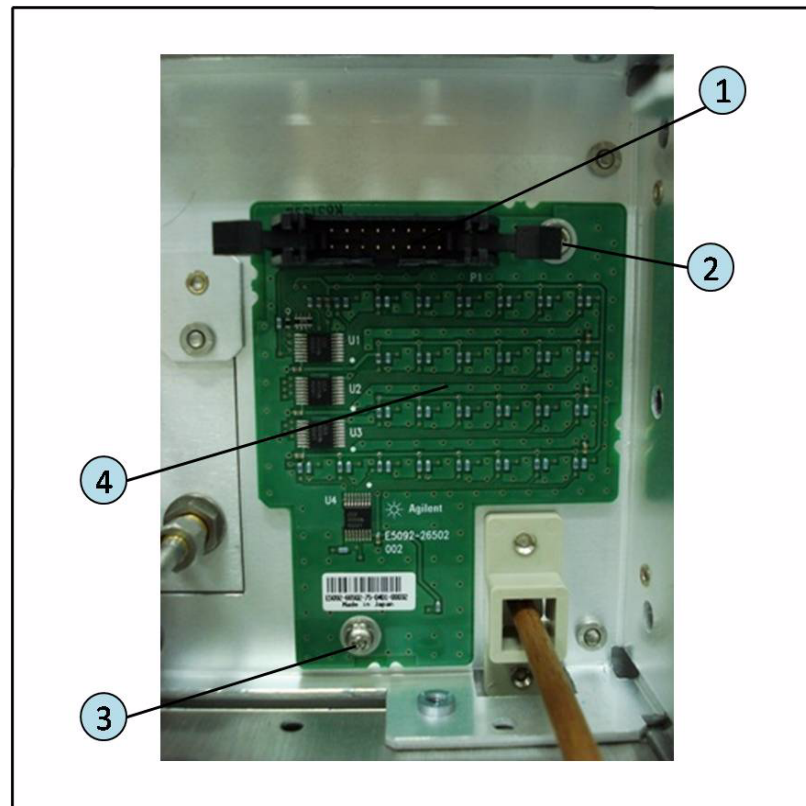

6 **Post-Repair Procedures**

This chapter lists the procedures required to verify the E5092A operation after an assembly is replaced with a new one.

Post-Repair Procedures

Table 6-1 *Post Repair Procedures* lists the required procedures that must be performed after the replacement of an assembly. These are the recommended minimum procedures to ensure that the replacement is successfully completed.

Table 6-1 **Post-Repair Procedures**

Replaced Assembly or Part	Required Adjustments Correction Constants (CC)	Verification
Switch Control USB PCA (E5092-66601)	No adjustment needed	Perform the following performance tests. - Write SN - DC Source Output Voltage Accuracy Test - DC Source Maximum Current Test - Control Line Maximum Current Test - LED Check - DCBUS Check
Switch Indicator LED PCA (E5092-66602)	No adjustment needed	Perform the following performance tests. - Write SN - DC Source Output Voltage Accuracy Test - DC Source Maximum Current Test - Control Line Maximum Current Test - LED Check - DCBUS Check
DUT Control PCA (E5092-66603)	No adjustment needed	Perform the following performance tests. - Write SN - DC Source Output Voltage Accuracy Test - DC Source Maximum Current Test - Control Line Maximum Current Test - LED Check - DCBUS Check

Table 6-1 Post-Repair Procedures

Replaced Assembly or Part	Required Adjustments Correction Constants (CC)	Verification
Switch 5 (SPDT Switch Bias Pin Adapter PCA) (E5092-66504)	No adjustment needed	Perform the following performance tests. - Write SN - Load Match, Insertion Loss and Isolation Test for Switch 5 (SPDT, 5COM, 5A and 5B) - LED Check - DCBUS Check
Switch 6 (SPDT Switch Bias Pin Adapter PCA) (E5092-66504)	No adjustment needed	Perform the following performance tests. - Write SN - Load Match, Insertion Loss and Isolation Test for Switch 6 (SPDT, 6COM, 6A and 6B) - LED Check - DCBUS Check
Switch 7 (SPDT Switch Bias Pin Adapter PCA) (E5092-66504)	No adjustment needed	Perform the following performance tests. - Write SN - Load Match, Insertion Loss and Isolation Test for Switch 7 (SPDT, 7COM, 7A and 7B) - LED Check - DCBUS Check
Switch 8 (SPDT Switch Bias Pin Adapter PCA) (E5092-66504)	No adjustment needed	Perform the following performance tests. - Write SN - Load Match, Insertion Loss and Isolation Test for Switch 8 (SPDT, 8COM, 8A and 8B) - LED Check - DCBUS Check
Switch 9 (SPDT Switch Bias Pin Adapter PCA) (E5092-66504)	No adjustment needed	Perform the following performance tests. - Write SN - Load Match, Insertion Loss and Isolation Test for Switch 9 (SPDT, 9COM, 9A and 9B) - LED Check - DCBUS Check

Table 6-1 Post-Repair Procedures

Replaced Assembly or Part	Required Adjustments Correction Constants (CC)	Verification
Switch 10 (SPDT Switch Bias Pin Adapter PCA) (E5092-66504)	No adjustment needed	Perform the following performance tests. - Write SN - Load Match, Insertion Loss and Isolation Test for Switch 10 (SPDT, 10COM, 10A and 10B) - LED Check - DCBUS Check
Switch 1 (SP4T Switch Bias Pin Adapter PCA) (E5092-66505)	No adjustment needed	Perform the following performance tests. - Write SN - Load Match, Insertion Loss and Isolation Test for Switch 1 (SP4T, Port1, 1A, 1B, 1C and 1D) - LED Check - DCBUS Check
Switch 2 (SP4T Switch Bias Pin Adapter PCA) (E5092-66505)	No adjustment needed	Perform the following performance tests. - Write SN - Load Match, Insertion Loss and Isolation Test for Switch 2 (SP4T, Port2, 2A, 2B, 2C and 2D) - LED Check - DCBUS Check
Switch 3 (SP4T Switch Bias Pin Adapter PCA) (E5092-66505)	No adjustment needed	Perform the following performance tests. - Write SN - Load Match, Insertion Loss and Isolation Test for Switch 3 (SP4T, Port3, 3A, 3B, 3C and 3D) - LED Check - DCBUS Check
Switch 4 (SP4T Switch Bias Pin Adapter PCA) (E5092-66505)	No adjustment needed	Perform the following performance tests. - Write SN - Load Match, Insertion Loss and Isolation Test for Switch 4 (SP4T, Port4, 4A, 4B, 4C and 4D) - LED Check - DCBUS Check

Table 6-1 Post-Repair Procedures

Replaced Assembly or Part	Required Adjustments Correction Constants (CC)	Verification
Switch 5 (20GHz SPDT Pin Switch Module) (P9397-60001)	No adjustment needed	Perform the following performance tests. - Write SN - Load Match, Insertion Loss and Isolation Test for Switch 5 (SPDT, 5COM, 5A and 5B) - LED Check - DCBUS Check
Switch 6 (20GHz SPDT Pin Switch Module) (P9397-60001)	No adjustment needed	Perform the following performance tests. - Write SN - Load Match, Insertion Loss and Isolation Test for Switch 6 (SPDT, 6COM, 6A and 6B) - LED Check - DCBUS Check
Switch 7 (20GHz SPDT Pin Switch Module) (P9397-60001)	No adjustment needed	Perform the following performance tests. - Write SN - Load Match, Insertion Loss and Isolation Test for Switch 7 (SPDT, 7COM, 7A and 7B) - LED Check - DCBUS Check
Switch 8 (20GHz SPDT Pin Switch Module) (P9397-60001)	No adjustment needed	Perform the following performance tests. - Write SN - Load Match, Insertion Loss and Isolation Test for Switch 8 (SPDT, 8COM, 8A and 8B) - LED Check - DCBUS Check
Switch 9 (20GHz SPDT Pin Switch Module) (P9397-60001)	Not adjustment needed	Perform the following performance tests. - Write SN - Load Match, Insertion Loss and Isolation Test for Switch 9 (SPDT, 9COM, 9A and 9B) - LED Check - DCBUS Check

Table 6-1 Post-Repair Procedures

Replaced Assembly or Part	Required Adjustments Correction Constants (CC)	Verification
Switch 10 (20GHz SPDT Pin Switch Module) (P9397-60001)	Not adjustment needed	Perform the following performance tests. - Write SN - Load Match, Insertion Loss and Isolation Test for Switch 10 (SPDT, 10COM, 10A and 10B) - LED Check - DCBUS Check
Switch 1 (20GHz SP4T Pin Switch Module) (P9398-60001)	No adjustment needed	Perform the following performance tests. - Write SN - Load Match, Insertion Loss and Isolation Test for Switch 1 (SP4T, Port1, 1A, 1B, 1C and 1D) - LED Check - DCBUS Check
Switch 2 (20GHz SP4T Pin Switch Module) (P9398-60001)	No adjustment needed	Perform the following performance tests. - Write SN - Load Match, Insertion Loss and Isolation Test for Switch 2 (SP4T, Port2, 2A, 2B, 2C and 2D) - LED Check - DCBUS Check
Switch 3 (20GHz SP4T Pin Switch Module) (P9398-60001)	No adjustment needed	Perform the following performance tests. - Write SN - Load Match, Insertion Loss and Isolation Test for Switch 3 (SP4T, Port3, 3A, 3B, 3C and 3D) - LED Check - DCBUS Check
Switch 4 (20GHz SP4T Pin Switch Module) (P9398-60001)	No adjustment needed	Perform the following performance tests. - Write SN - Load Match, Insertion Loss and Isolation Test for Switch 4 (SP4T, Port4, 4A, 4B, 4C and 4D) - LED Check - DCBUS Check

A **Power Requirement**

Power Supply and fuse

Before turning on the E5092A, be sure to verify the following:

Power Requirements

The E5092A requires the following power source:

	Requirements
Voltage	90 to 132 VAC or 198 to 264 VAC *1
Frequency	47 to 63 Hz
Maximum power consumption	70 VA

*1. The E5092A automatically switches between them depending on the voltage.

Setting up fuse

Use the fuse that meets the following specifications.

UL/CSA type, Slo-Blo, 5×20 mm miniature fuse, 3A 250V (Agilent part number: 2110-1017)

Spare fuses are available from Agilent Technologies sales office. To check or replace the fuse, disconnect the power cable and pull out the fuse holder.

Figure A-1

Fuse holder and power cable inlet

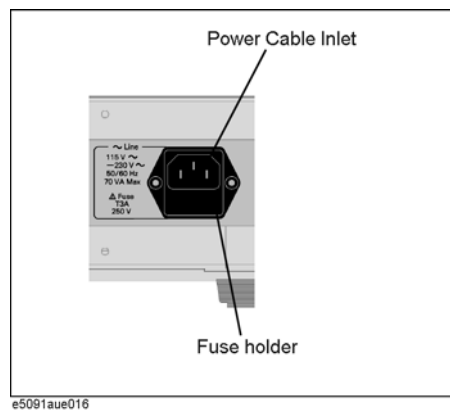

Power Cable

In accordance with international safety standards, this instrument is equipped with a three-wire power cable. When connected to an appropriate ac power outlet, this cable grounds the instrument frame. The type of power cable shipped with each instrument depends on country of destination.

WARNING



For protection from electrical shock, the power cable ground must not be defeated.
The power plug must be plugged into an outlet that provides a protective earth ground connection.

Turning the Power ON and OFF

This section describes how to turn ON/OFF the E5092A and how to cut the supply of power in an emergency.

Turning ON/OFF the power



Turning ON power

Step 1. Check that the line switch in the lower left part of the front panel is pulled up (). If it is pushed in () which means the power is OFF, push the standby switch to pull it up ().

Step 2. Push the line switch to push it in ().

Turning OFF power

To turn OFF the E5092A, do the following.

- Push the line switch in the lower left part of the front panel so that the switch pushed in () is pulled up ().

NOTE

To turn OFF the E5092A in normal times, press the line switch. **In normal times, never disconnect the power cable to cut the supply of power to the power cable receptacle on the rear panel.**

Cutting supply of power

For the E5092A, the disconnecting device (the device to cut the supply of power) is the plug of the power cable (on the power outlet side or the E5092A side). If you need to cut the supply of power to avoid danger of electric shocks, disconnect the plug of the power cable (on the power outlet side or the E5092A side).

NOTE

To turn OFF the power in normal times, be sure to follow the procedure in “Turning OFF power”.
